

# ESPLOSO E LISTA RICAMBI FONDITAL GROUP

*Alor*

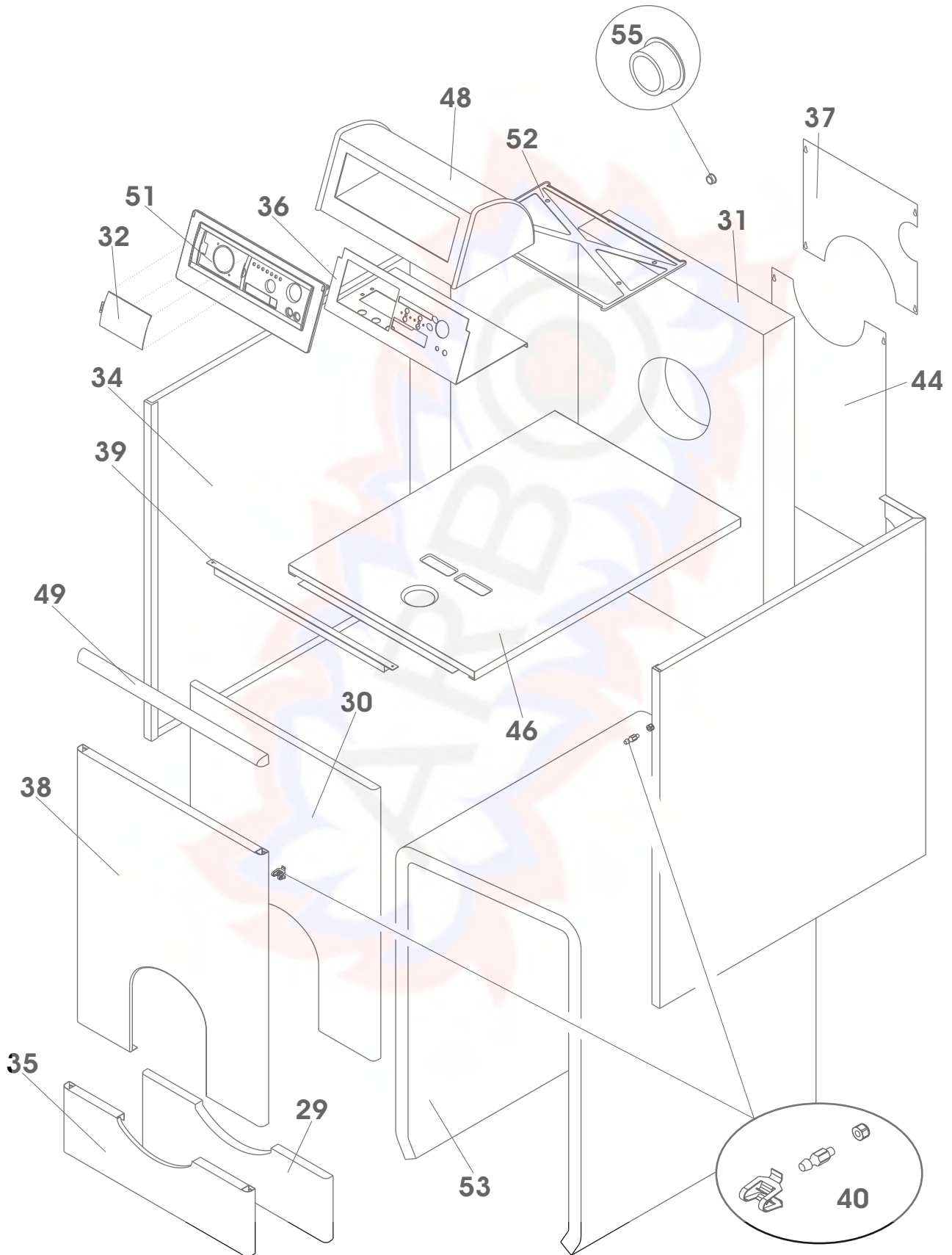

*Scudo*



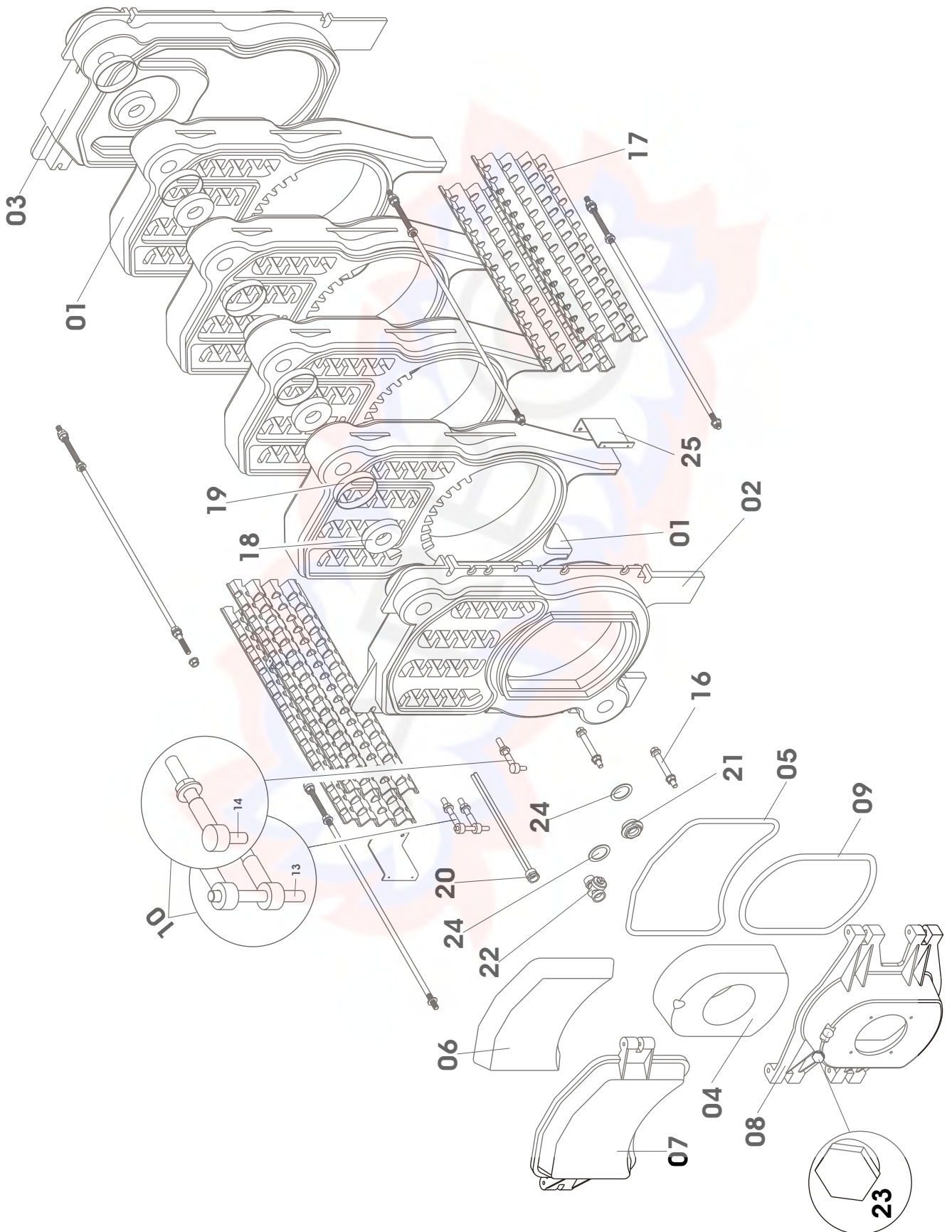

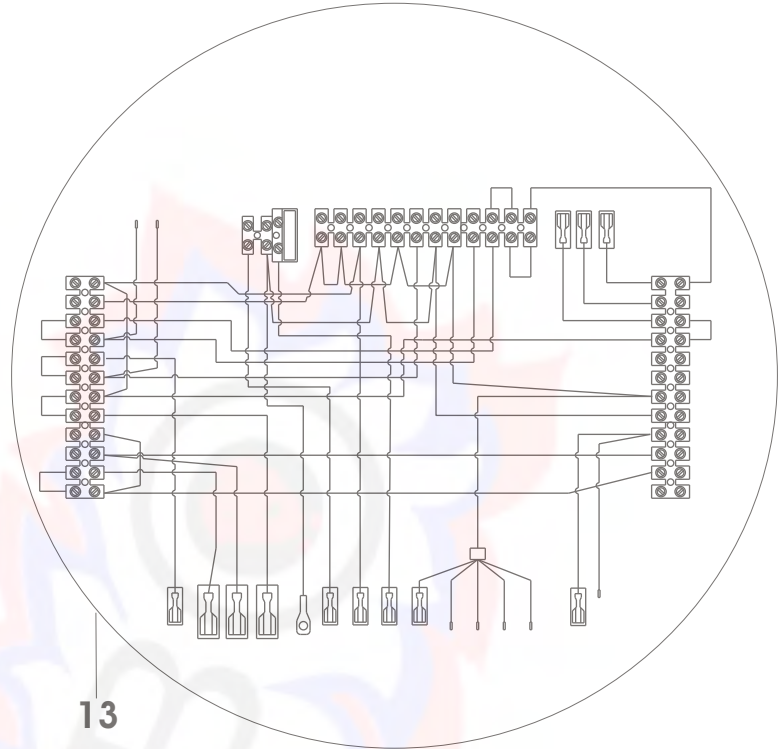
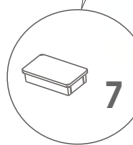
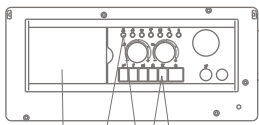
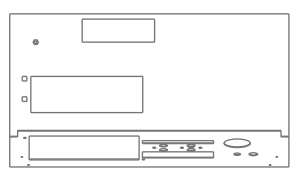
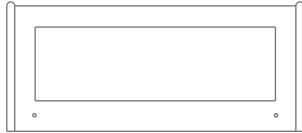
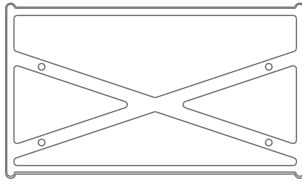

13

15



14

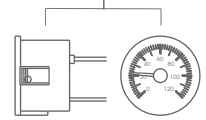

16



10

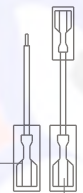

12

11

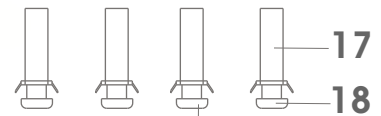

19

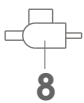

8

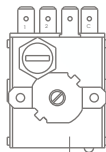

23

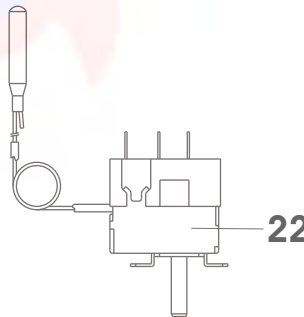

22



21

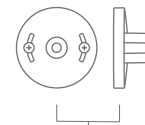

20

### Riferimenti esploso Alor - Scudo

Esp	Codice Fondital	Pezzi	Descrizione	Description
1	6ELESCME01	1	ELEMENTO SCAMBIATORE MEDIO	CENTRAL HEAT EXCHANGER ELEMENT
2	6ELESCPR01	1	ELEMENTO SCAMBIATORE PRINCIPALE	MAIN HEAT EXCHANGER ELEMENT
3	6ELESCUL01	1	ELEMENTO SCAMBIATORE POSTERIORE	REAR HEAT EXCHANGER ELEMENT
4	6ISOPIBR00	1	ISOLANTE PORTA BRUCIATORE	BURNER HOLDER INSULATION
5	6TRFCISO00	1	CORDA ISOLANTE PORTA PULIZIA	INSPECTION DOOR INSULATION STRIP
6	6ISOPOPU00	1	ISOLANTE PORTA PULIZIA	INSPECTION DOOR INSULATION
7	6PORPUAN00	1	PORTINA DI PULIZIA	CLEANING DOOR
8	6PIAPOBR00	1	PORTINA PER BRUCIATORE	BURNER DOOR FOR
9	6CORDBRU00	1	CORDA ISOLANTE PORTA BRUCIATORE	INSPECTION DOOR INSULATION STRIP
10	6TIRAOC00	4	TIRANTE A OCCHIO M12X112	EYE TIE ROD M12X112
13	6PERNOXX01	2	PERNO 10x100 (2 PEZZI)	PIN 10x100 FOR (2-pc. pack)
14	6PERNOXX02	2	PERNO 10x80	PIN 10x80 FOR
16	6TIRPORT00	1	TIRANTE CHIUSURA PORTINE 12x130	DOOR CLOSING TIE ROD 12x130
17	6TURBGHI00	1	TURBOLATORE PER CORPO IN GHISA	TURBOFAN FOR CAST IRON BODY
18	6GUARMOZ00	4	GUARNIZIONE TENUTA MOZZI	HUB SEAL
19	6ANEGUAR00	4	ANELLO DI CONTENIMENTO PER GUARN.	SEAL RETAINING RING
20	6PORTBUT02	1	PORTA BULBI L 360mm X	BULB HOLDER L 360mm X
21	6RIDUZIO00	1	RIDUZIONE 1-1-4 M x 3-4 F	REDUCER 1-1-4 M x 3-4 F
22	6RUBISCA05	1	RUBINETTO DI SCARICO 3-4 M	DRAIN COCK 3-4 M
23	6TAPPOXX01	1	TAPPO 3/4 MASCHIO	PLUG 3/4 MALE
24	6GUARNIZ10	5	GUARNIZIONE 56x41x2	GASKET 56x41x2
25	6STAFSUP04	1	STAFFA PANNELLO LATERALE CORPO SCAMB.	SIDE PANEL BRACKET FOR HEAT EXCHANGER BODY
29	6ISOLPAI00	1	ISOLAMENTO TERMICO ANTERIORE INFERIORE	REAR LOWER THERMAL INSULATION
30	6ISOLPAS00	1	ISOLAMENTO TERMICO ANTERIORE SUPERIORE	FRONT UPPER THERMAL INSULATION
31	6ISOLSCH00	1	ISOLAMENTO TERMICO PER SCHIENALE CALDAIA	THERMAL INSULATION FOR BOILER REAR PART
32	6SPORPAN01	1	SPORTELLINO PANNELLO FONDITAL	FONDITAL PANEL DOOR
	6SPORPAN02	1	SPORTELLINO PANNELLO NOVA FLORIDA	NOVA FLORIDA PANEL DOOR
	6PANLATR00	1	PANNELLO LATERALE PER CALDAIA 6 ELEMENTI	SIDE PANEL FOR 6-ELEMENT BOILER
	6PANLATR01	1	PANNELLO LATERALE PER CALDAIA 7 ELEMENTI	SIDE PANEL FOR 7-ELEMENT BOILER
34	6PANLATR02	1	PANNELLO LATERALE PER CALDAIA 8 ELEMENTI	SIDE PANEL FOR 8-ELEMENT BOILER
	6PANLATR03	1	PANNELLO LATERALE PER CALDAIA 9 ELEMENTI	SIDE PANEL FOR 9-ELEMENT BOILER
	6PANLATR04	1	PANNELLO LATERALE PER CALDAIA 10 ELEMENTI	SIDE PANEL FOR 10-ELEMENT BOILER
35	6PANNANT01	1	PANNELLO ANTERIORE INFERIORE	LOWER FRONT PANEL
36	6LAPORST00	1	LAMIERA PORTA STRUMENTI	INSTRUMENT PANEL SHEET
37	6SCHPOST00	1	SCHIENALE POSTERIORE SUPERIORE	UPPER REAR PANEL
38	6PANNANT00	1	PANNELLO ANTERIORE SUPERIORE	UPPER FRONT PANEL



39	6TRAVERS00	1	TRAVERSA DI RINFORZO MANTELLO CALDAIA	BOILER SHELL CROSS ELEMENT
40	6KRICAPB00	10	KIT AGGANCIAMENTO PANNELLATURE	PANEL HOOKING KIT
44	6SCHPOST01	1	SCHIENALE POST. X CALDAIA PARTE INF	REAR PANEL FOR BOTTOM PART OF THE BOILER
46	6COPCALE06	1	COPERCHIO PER CALDAIA 6 EL.	COVER FOR 6-EL. BOILER
	6COPCALE07	1	COPERCHIO PER CALDAIA 7 EL.	COVER FOR 7-EL. BOILER
	6COPCALE08	1	COPERCHIO PER CALDAIA 8 EL.	COVER FOR 8-EL. BOILER
	6COPCALE09	1	COPERCHIO PER CALDAIA 9 EL.	COVER FOR 9-EL. BOILER
	6COPCALE10	1	COPERCHIO PER CALDAIA 10 EL.	COVER FOR 10-BOILER
48	6CALOSAT00	1	CALOTTA SATELLITE PANNELLO COMANDI	SATELLITE CONTROL PANEL HOOD
49	6PROFIPL02	1	PROFILO IN PLASTICA L 600 MM	PLASTIC SECTION L 600 MM
51	6PANNELL09	1	PANNELLO STRUMENTI CALDAIA	BOILER INSTRUMENT PANEL
52	6GUARCAL00	1	GUARNIZIONE PER CALOTTA SATELLITE	GASKET FOR SATELLITE HOOD
53	6ISOLCSC00	1	ISOLAMENTO PRINCIPALE 80	MAIN INSULATION 80
	6ISOLCSC01	1	ISOLAMENTO PRINCIPALE 100	MAIN INSULATION 100
	6ISOLCSC02	1	ISOLAMENTO PRINCIPALE 120	MAIN INSULATION 120
	6ISOLCSC03	1	ISOLAMENTO PRINCIPALE 140	MAIN INSULATION 140
	6ISOLCSC04	1	ISOLAMENTO PRINCIPALE 160	MAIN INSULATION 160
55	6PASSACA01	5	PASSACAVO IN PLASTICA	PLASTIC FAIRLEAD
<b>QUADRO ELETTRICO</b>				
6	6TAPSPLU00	10	TAPPO SPIA LUMINOSA	SIGNAL LAMP PLUG
7	6TAPPINT00	5	TAPPO INTERRUTTORE	SWITCH PLUG
8	6BLOCAVO00	5	BLOCCACAVO	CABLE CLAMP
10	6COLLEGA05	1	COLLEGAMENTO A TPB L3 L5	CONNECTION TO TPB L3 L5
11	6COLLEGA20	1	COLLEGAMENTO IE	IE CONNECTION
12	6COLLEGA26	1	CONNESSIONE PER ALIMENTATORE	POWER SUPPLY CONNECTION
13	6CABQEE00	1	CABLAGGIO X QUADRO ELETTRICO	CABLE FOR ELECTRICAL UNIT
14	6TERMOMT01	1	TERMOMETRO CAPILLARE 1.5M	CAPILLARY THERMOMETER 1.5M
15	6INTERRU01	3	INTERRUTTORE GENERALE LUMINOSO	MASTER ILLUMINATED SWITCH
16	6DEVIUNI00	3	DEVIATORE UNIPOLARE	UNIPOLAR SWITCH
17	6SEGNNEO00	10	SEGNALATORE AL NEON 230V	NEON INDICATOR 230V
18	6GEMGIAL00	10	GEMMA D6 GIALLA	YELLOW BUD D6
19	6GEMROSS00	10	GEMMA D6 ROSSA	RED BUD D6
20	6TAPPMAN00	5	TAPPO REGOLAZIONE SANITARIO	DHW REGULATION PLUG
21	6MANOTER00	5	MANOPOLA PER TERMOSTATI	THERMOSTAT KNOB
22	6BITERRE00	1	BITERMOSTATO REGOLAZIONE CAPILLARE 1.5M	CAPILLARY REGULATION BITERMOSTAT 1.5M
23	6TERMSIC04	1	TERMOST SICUREZZA 100° CAPILLARE 1.5M	CAPILLARY SAFETY THERMOSTAT 100° 1.5M