



Lamborghini
CALORECLIMA

AZIENDA CERTIFICATA ISO 9001



PREGASI CONSEGNARE
L'INSERTO "MANUALE D'USO"
AL SIG. UTENTE
PLEASE MAKE SURE THAT THE
"USE MANUAL" IS HANDED
OVER TO THE USER
TENGAN LA AMABILIDAD DE
ENTREGARLE AL USUARIO EL
"MANUAL DE USO"
FAVOR ENTREGAR O
"MANUAL DE USO"
AO SR. UTENTE

CALDAIA MURALE A GAS PER ESTERNO - ALTO RENDIMENTO - MODULANTE
WALL-HUNG GAS BOILER FOR OUTDOOR INSTALLATION - HIGH EFFICIENCY - MODULATING UNIT
CALDERA MURAL A GAS PARA EXTERIOR - ALTO RENDIMIENTO - MODULANTE
CALDEIRA DE PAREDE A GÁS PARA AMBIENTES EXTERNOS - ALTO RENDIMENTO - MODULÁVEL



thin 24 MCS W TOP U/IT

MANUALE DI
INSTALLAZIONE E
MANUTENZIONE

INSTALLATION
AND MAINTENANCE
MANUAL

MANUAL PARA
LA INSTALACIÓN Y
EL MANTENIMIENTO

MANUAL DE
INSTALAÇÃO E
MANUTENÇÃO



INDEX	PAGE
GENERAL INSTRUCTIONS _____	39
DESCRIPTION _____	40
MAIN COMPONENTS _____	41
DIMENSIONS _____	42
TECHNICAL FEATURES _____	42
NOZZLE CALIBRATION _____	43
ELECTRICAL CONNECTIONS - WIRING DIAGRAMS _____	44
INSTALLATION AND START-UP _____	47
SETTING THE TIME/DAY OF THE WEEK _____	48
MODES _____	48
“AUTOMATIC” TEMPERATURE CONTROL MODE _____	49
“MANUAL” TEMPERATURE CONTROL MODE _____	50
SETTING THE TEMPERATURE _____	51
VIEWING MAIN BOILER PARAMETERS _____	52
RE-ESTABLISHING FACTORY SETTINGS AND CONTROL RESET _____	53
ERROR MESSAGES _____	53
INSTALLER SETTINGS _____	54
HYDRAULIC CONNECTION _____	56
HYDRAULIC CIRCUIT _____	57
INSTALLATION _____	58
STARTING UP _____	58
FLUE EXHAUST TYPES _____	59
FLUE EXHAUST CONNECTION _____	60
FLUE EXHAUST INSTALLATION _____	62
ADJUSTMENTS _____	63
SWITCHING OFF _____	64
MAINTENANCE _____	64
OPERATION WITH DIFFERENT TYPES OF GAS _____	65
ANTI-FREEZE KIT (ON REQUEST) _____	66
FAULT-FINDING CHART _____	67

Congratulations....

.....on an excellent choice.

We thank you for the preference accorded to our products.

LAMBORGHINI CALORECLIMA has been actively present in Italy and throughout the world since 1959 with a widespread network of agents and concessionary agents to constantly guarantee the presence of our product on the market. Alongside this is the support of a technical service, “LAMBORGHINI SERVICE”, which is entrusted with the qualified servicing of the product.

For the installation and positioning of the boiler:
CAREFULLY OBSERVE THE LOCAL REGULATIONS IN FORCE



Lamborghini
CALORECLIMA

**DECLARATION OF CONFORMITY
WITH EUROPEAN COMMUNITY STANDARDS**

The undersigned, Bruno Marchesi, Managing Director of LAMBORGHINI CALOR S.p.A.
with head offices in Via Statale 342, Dosso (FE) ITALY

DECLARES THAT THE OUTDOOR WALL HUNG GAS BOILERS

LAMBY - IN 20 MCS W TOP

**LAMBY 20 MCS W TOP
THIN 24 MCS W TOP**

conform with EC regulations and, more specifically, comply with the following standards (or unified standards):

EN 60335-1, pr EN 50165, EN 50081-1, EN 50082-1, pr EN 483, EN 297, EN 297 pr A6

in accordance with the following directives:

- Gas Directive EEC 90/396
- Low Voltage Directive EEC 73/23 (amended by 93/68)
- Electromagnetic Compatibility Directive EEC 89/336 (amended by 93/68)
- Efficiency Directive EEC 92/42

Dosso, 30/03/99

Lamborghini Calor S.p.A.
Managing Director
Bruno Marchesi



GENERAL INSTRUCTIONS

- This booklet constitutes an integral and essential part of the product. Read carefully the instructions contained in this booklet as they provide important directions regarding the safety of installation, use and maintenance. Preserve this booklet with care for any further consultation. The installation of the boiler must be carried out in compliance with current regulations, according to the instructions of the manufacturer and by qualified personnel. An incorrect installation can cause injury or damage to persons, animals and objects, for which the manufacturer cannot be held responsible.
- After removing the packaging materials, check the content integrity. In case of doubt, do not use the unit and contact the supplier. The packaging material (wooden crates, nails, clips, plastic bags, foam, etc.) must not be left within reach of children as they are potential sources of danger.
- This boiler is designed to heat water to a temperature below boiling (atmospheric pressure). It must be connected to a heating system compatible with its performances and output.
- This appliance should be destined only for the use for which it has been expressly envisaged. Any other use is to be considered improper and therefore dangerous. The manufacturer cannot be considered responsible for any damages caused from improper, erroneous or unreasonable use.

ALL INSTALLATION, MAINTENANCE AND GAS CONVERSION OPERATIONS MUST BE CARRIED OUT BY AUTHORISED SKILLED TECHNICIANS.

TO ENSURE THAT BOILER IS INSTALLED CORRECTLY AND THAT IT FUNCTIONS PROPERLY, WE RECOMMEND THAT ONLY LAMBORGHINI ACCESSORIES AND SPARE PARTS BE USED.

ON NOTICING THE SMELL OF GAS DO NOT TOUCH ANY ELECTRIC SWITCH. OPEN DOORS AND WINDOWS, SHUT OFF THE GAS COCKS.

WARNING: FIT A SAFETY DEVICE ON THE FLUE EXHAUST DUCT SO AS TO ELIMINATE ANY SOURCE OF DANGER TO CHILDREN OR ADULTS AND PREVENT CONTACT WITH FLAMMABLE MATERIALS.



DESCRIPTION

The **THIN** boiler has been designed for outdoor installation in partially protected areas and can operate at winter temperatures as low as -15°C . It is largely intended for installation on balconies and terraces. This unit is practically "invisible" as it is designed to be wall-mounted just 80 mm above the floor.

The boiler is equipped with an anti-freeze system designed to protect the heating and domestic hot water circuits; when necessary, this ignites the burner until the set minimum water temperature is restored. To cover all eventualities, an electrical element kit, to be fitted on the domestic hot water circuit, is also available.

This unit has passed all the tests required by strict European Community safety standards.

The boiler has IP44 protection rating, is fully automatic with continuous flame modulation and ionisation ignition; it is C-type and can be installed as a sealed chamber or fan-forced draught unit.

All ignition, shut-down, adjustment, programming, display and self-diagnosis functions are effected by a **master** remote control unit.



MAIN COMPONENTS

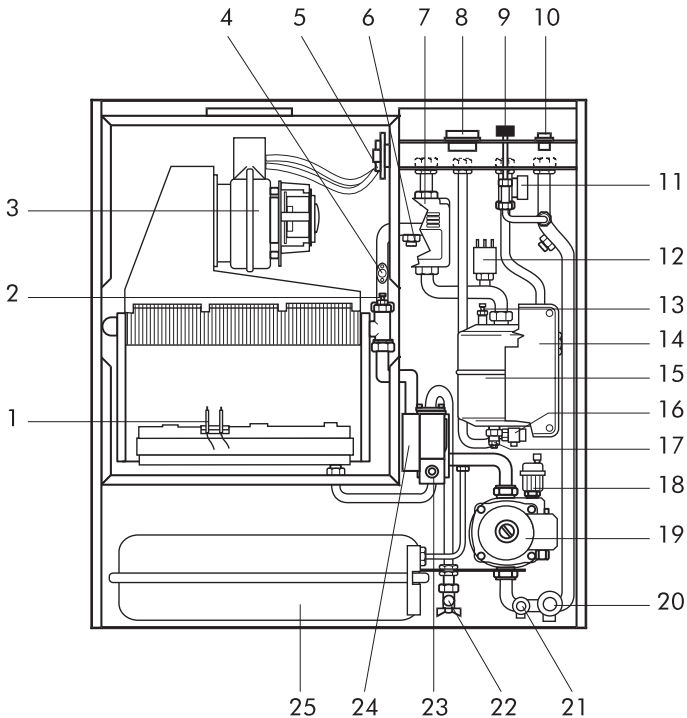

LEGEND

- | | | | |
|----|---|----|------------------------------|
| 1 | Ignition electrodes | 15 | Instantaneous water-heater |
| 2 | Manual air purge valve | 16 | Hot water circuit drain cock |
| 3 | Fumes fan | 17 | Hot water detector |
| 4 | Total safety thermostat | 18 | Automatic air purge valve |
| 5 | Fumes pressure switch | 19 | Circulating pump |
| 6 | Heating detector | 20 | Heating safety valve |
| 7 | 3-way valve | 21 | Heating circuit drain cock |
| 8 | Hydrometer | 22 | Gas cock |
| 9 | Filling cock | 23 | Gas valve |
| 10 | Reset push-button with lock-out warning light | 24 | Electronic control unit |
| 11 | Hot water pressure switch | 25 | Expansion tank |
| 12 | Lack of water pressure switch | | |
| 13 | Manual air purge valve | | |
| 14 | Electric box | | |



DIMENSIONS mm

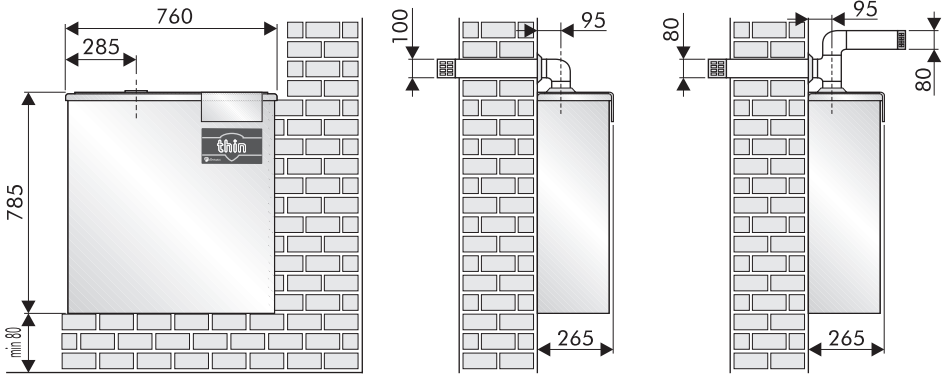

TECHNICAL FEATURES

MODEL	Thermal capacity		Min. thermal capacity				Connections				Operating pressure		Hot water supply		Expansion tank	Weight				
	Input		Output		Input		Output		Main system		Hot water system		Heating circuit	Hot water circuit			Continuous supply $\Delta 30^{\circ}\text{C}$	Min. supply		
	kW	kcal/h	kW	kcal/h	kW	kcal/h	kW	kcal/h	Supply	Return	Gas	Inlet		Outlet					min.	max.
THIN 24MCS W TOP	30,45	26.187	27,7	23.822	14,2	12.212	12,66	10.887	3/4"	3/4"	3/4"	1/2"	1/2"	3	0,4	6	13,2	2,5	8	56

Boiler version: mod. C type C12-C32-C42-B22
Category: II 2H3+

Max. water temperature 90°C
Rated gas pressure: Natural gas 20 mbars
B 28/30 mbars - P 37 mbars

CIRCULATING PUMP FEATURES

Delivery/pressure available at the system

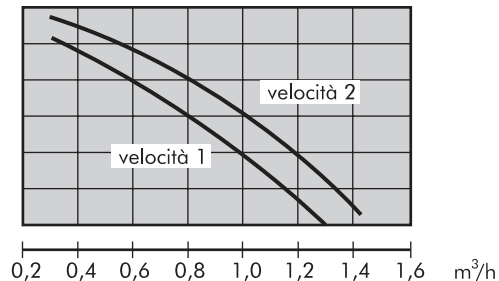
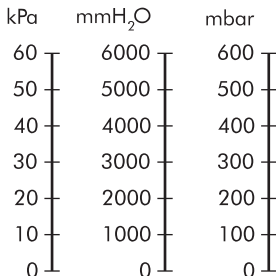



GAS - NOZZLE CALIBRATION

The boilers leave the factory calibrated and predisposed to operate with NATURAL GAS and LIQUID GAS. These calibrations are effected without the connection of the compensating joint (Pos. A).

For the calibrations to put into effect, see the table related below:

Gas type	Pressure on nozzles mbars		Delivery m ³ /h	Burner nozzles Ø mm.	L.C.V. kcal/h
	min.	max.			
NATURAL GAS (G20-20mbars)	2	11	3,06	1,25	8.550
LIQUID GAS B (G30-28/30mbars)	5	25	0,89	0,77	29.330
LIQUID GAS P (G31-37mbars)	6,2	32	1,17	0,77	22.360

BURNER PRESSURE CURVES - OUTPUT

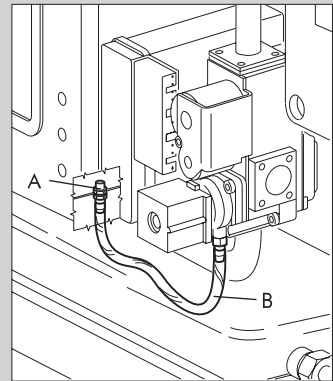
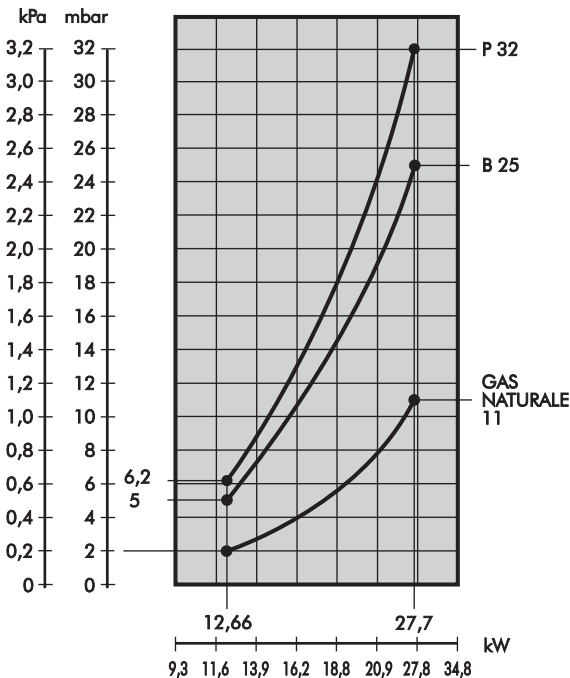

A Compensating joint
B Connecting pipe

To effect the gas valve calibration, proceed as follows:

- take the pipe **B** off the joint **A**;
- effect calibration;
- connect the pipe **B** again to the joint **A**.



ELECTRICAL CONNECTIONS - WIRING DIAGRAMS

The boiler must be connected to an earthed, single-phase 220-230V-50 Hz mains supply by means of a three-wire cable, ensuring that connections to the LINE and NEUTRAL terminals are made correctly. A bipolar switch must be used with contacts opening to at least 3 mm. The power lead must only be replaced by another with the following characteristics: "HAR H05 VV-F" 3 X 0.75 mm².

The boiler is equipped with a 1 m lead for connection of the remote control unit. If this is not long enough for the intended control unit position it must be replaced with a lead of appropriate length. The control unit must be fitted on an internal wall about 1.5 m above the floor. Do not fit near heat sources or in direct sunlight. Avoid installation in corners, alcoves, behind doors or curtains etc. Attach the unit to the wall with the supplied expansion plugs. A through-hole is previewed to allow for passage of the electrical wiring. The control unit can also be fitted directly on a standard 3-module junction box. Connection to the boiler requires two wires with a minimum cross-section of 0.5 mm² which must not exceed 50 m in length. The positive pole is to be connected to terminal 5 and the negative pole to terminal 4. Accidental inversion of polarity, while not damaging the control unit, will stop it functioning.

**Installation must be made in compliance with safety REGULATIONS IN FORCE.
Make a good earth connection.**

Voltage	Frequency	Absorbed power	Protection index	Noise level
V	Hz	kW	IP	dB (A)
230	50	0,148	44	45

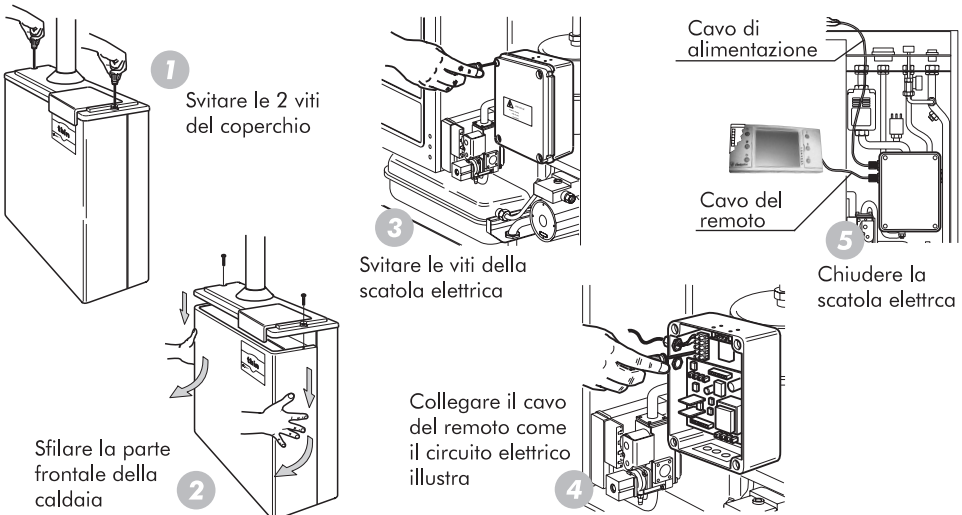



PRINCIPLE DIAGRAM

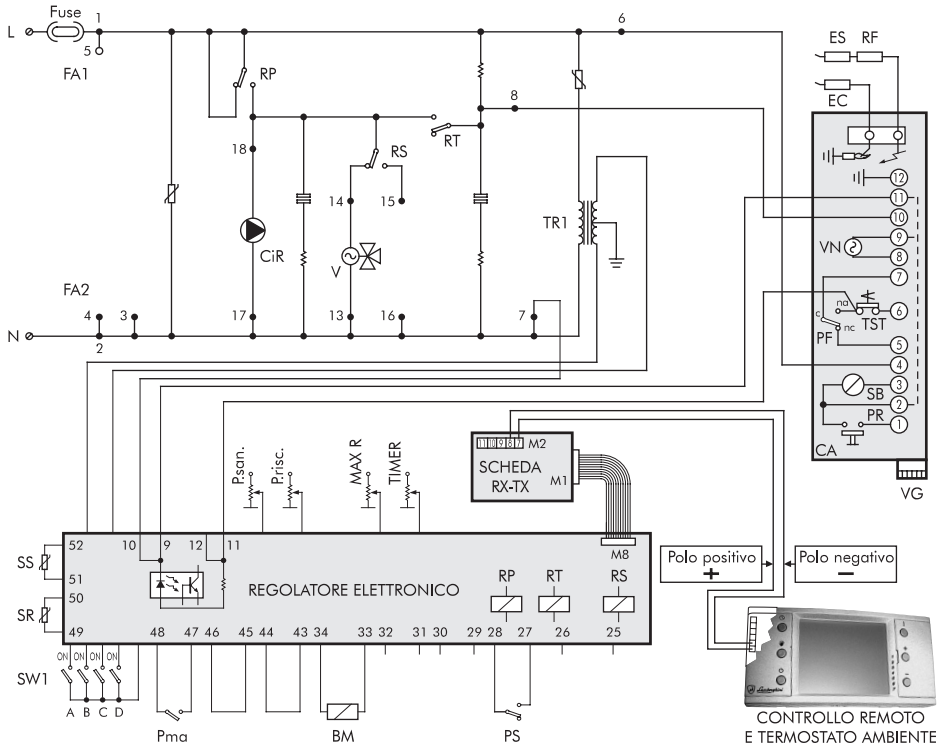

LEGEND

- | | |
|---|---|
| BM Modulating coil | RS R4 relay contact |
| CA Ignition control unit Honeywell | RP RL2 relay contact |
| CIR Circulating pump | RF Anti-interference resistance |
| EC Control electrode | SB Lock-out warning light |
| ES Spark electrode | SR Heating detector |
| L Line | SS Hot water/water-heater detector |
| MAX R Max. heating setting | SW1 Function selector |
| N Neutral | TIMER Boiler timer adjustment |
| PF Fumes pressure switch | TR1 Transformer |
| P.ma Lack of water pressure switch | TST Total safety thermostat |
| PR Reset push-button | V 3-way valve |
| P.risc. Heating potentiometer | VG Gas valve |
| PS Hot water pressure switch | VN Fan |
| P.san. Hot water potentiometer | |
| RT RL3 relay contact | |

NOTE: Slow ignition (RLA) is of the mechanical type positioned on the gas valve as illustrated in the figure on page 65.



CIRCUIT DIAGRAM

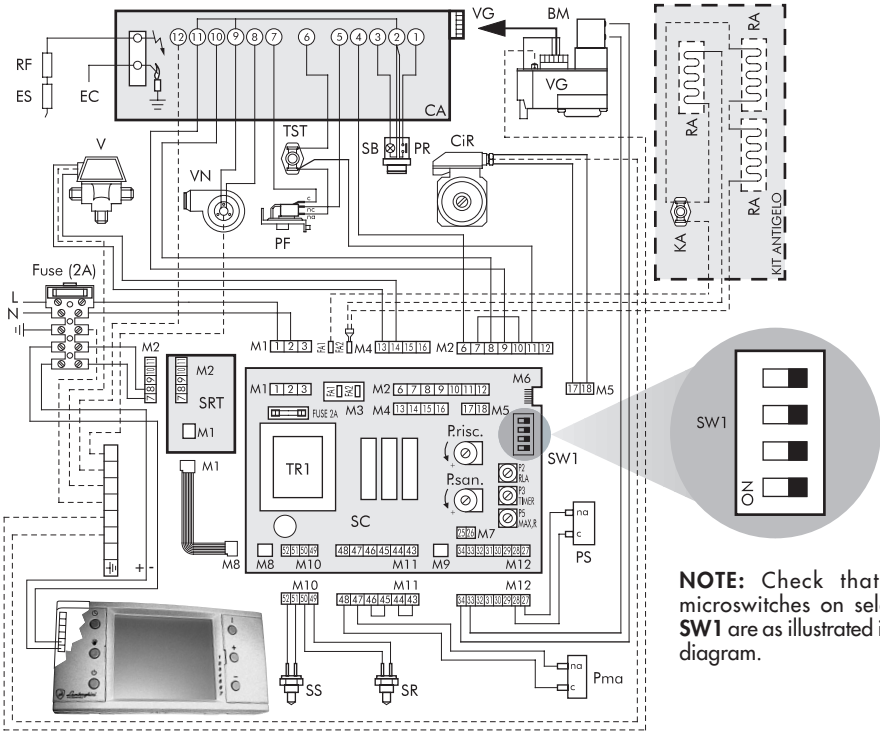

NOTE: Check that the microswitches on selector SW1 are as illustrated in the diagram.

LEGEND

- | | |
|---|---|
| BM Modulating coil | RA Anti-freeze element |
| CA Ignition control unit Honeywell | RF Anti-interference resistance |
| CR Remote control - room thermostat | SB Lock-out warning light |
| CIR Circulating pump | SC Connection card |
| EC Control electrode | SR Heating detector |
| ES Spark electrode | SRT RX-TX board |
| KA Anti-freeze thermostat (on request) | SS Hot water/water-heater detector |
| L Line | SW1 Function selector |
| MAX R Max. heating setting | TIMER Boiler timer adjustment |
| N Neutral | TR1 Transformer |
| PF Fumes pressure switch | TST Total safety thermostat |
| Pma Lack of water pressure switch | V 3-way valve |
| PR Reset push-button | VG Gas valve |
| P.risc. Heating potentiometer | VN Fan |
| PS Hot water pressure switch | |
| P.san. Hot water potentiometer | |



INSTALLATION AND START-UP

Remove the control unit base-block by levering the two lower hooks (fig. 1).

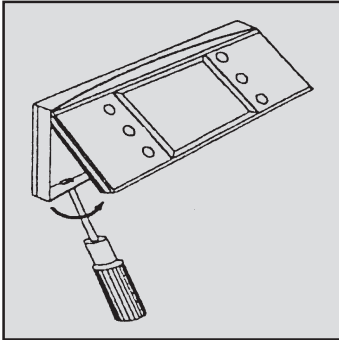

fig. 1

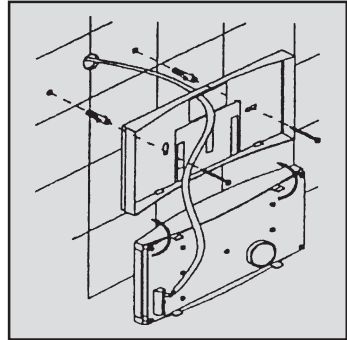

fig. 2

Fix the control unit to the wall via the holes in the base-block. This should be mounted 1.5 m above the floor in an area well away from entry/exit doors, windows or other factors that might influence room temperature readings (fig. 2).

After making sure that electrical power at the boiler is OFF proceed with the electrical connections using bi-polar wiring: do not route the wiring parallel to the main power supply wires/leads.

If it is not possible to avoid taking the same wiring route use a shielded lead, the braid of which must be connected to an earth.

Connect the lead extremities to the "+IN+" terminal block (fig. 3). It is highly important that you observe the indicated polarities (boiler + to control +, boiler - to control -)

Lead length must not exceed 50 m.

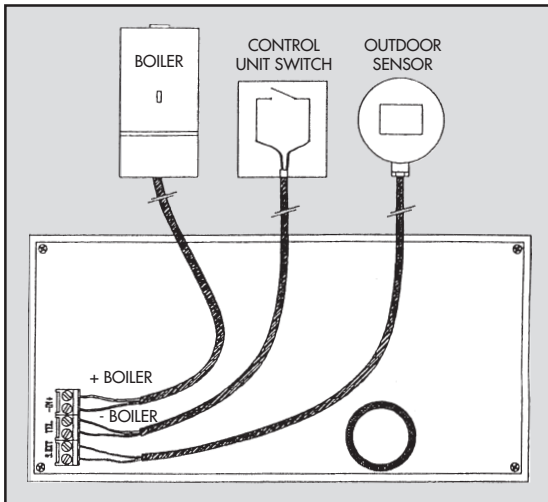



fig. 3



Once the connections have been made power up the boiler and, after the “CON” signal, check that the legend “OFF” appears on the main display and that the time 00:00 on the lower display and the day indicator both appear .

If the legend “CON” persists this indicates improper connection of the control unit to the boiler.

NOTE: In the event of a power failure the control unit will memorise the data for up to 24 hours.

SETTING THE TIME/DAY OF THE WEEK

You can set the clock time and the day of the week in any mode.

To begin setting press the **H/Day** key once.

The minute figures will then start flashing.

Press the + and – keys to set the minutes and then press **H/Day** again to confirm.

The hour figures on the display will now flash.

Press the + and – keys to set the hour and then press **H/day** again to confirm.

Once you have completed setting the clock time the day indicator  will begin flashing.

The  indicators signal the sequence of days from Monday to Sunday (1 = Monday, 2 = Tuesday etc.) Press the + and – keys to select the desired day then press **P** to memorise the settings.

MODES

The control unit runs the boiler by enabling or disabling each individual mode according to requirements.

Press the  key repeatedly and the following modes will be enabled in sequence: OFF, Hot water, Hot water/Heating and Heating.

- **OFF MODE (“OFF” APPEARS ON THE DISPLAY)**

This mode allows you to disable the Hot water and Heating functions, yet keeps the boiler safety functions operative.

In this mode any request for hot water and any request to switch on the heating circuit will be ignored.

- **“HOT WATER” MODE ( SYMBOL DISPLAYED)**

This function enables the boiler for production of hot water.

When this function is enabled it is possible to adjust the hot water to the desired temperature.

In this mode, any request to switch on the heating circuit will be ignored.





- **"HOT WATER/HEATING" MODE** ( AND . **SYMBOLS DISPLAYED**)
This mode provides both hot water and heating, operated automatically according to requirements.

- **"HEATING" FUNCTION** (. **SYMBOL DISPLAYED**)
This mode enables the boiler for activation of the heating circuit in "Automatic" or "Manual".
When this mode is selected you can adjust heating water temperature and set the on/off times to be used in automatic mode.
In this mode, any request for the production of hot water will be ignored.

"AUTOMATIC" TEMPERATURE CONTROL MODE





The control unit has a daily/weekly timer that automatically adjusts room temperature to "comfort" or "low temperature" values over a 24 hour period, with independent settings for each of the seven days.



To enable automatic operation press the  key and the  symbol will be displayed.
Hourly programming of temperature values is only permitted with the Heating or Hot water/Heating functions enabled.

● **HOURLY PROGRAMMING OF TEMPERATURE VALUES**

Press key **V** to select the desired day on the  indicators.
The display will then show the programme graph for the selected day by displaying the "indicator lights" next to the "comfort" level.

To modify these settings press **P** within 5 seconds.
The time "00:00" will now appear on the display and the indicator light corresponding to that time will begin to flash.
Press the **+** and **-** keys to increase or decrease the time in 30-minute steps.

The  and  symbols show the present value of the indicator light ( comfort temperature level and  low temperature level)

Select the desired value by acting on the  (comfort temperature level) and  (low temperature level) keys. The indicator light will take on the desired value and programming will advance by one step: the next indicator light to be programmed will then flash.
Once programming is over press **P** to memorise settings or **V** to cancel the modifications.
The timer can memorise up to 48 daily temperature value changes.



● **COPYING HOURLY PROGRAMMING**

To speed up programming, you can “paste” the settings for a specific day onto another day. Press **V** to select the day from which you wish to copy the settings.

Press the **Copy** key within 5 seconds to copy and then press the + and – keys to select the page onto which you intend to “paste” them (the “destination” day is indicated by a flashing  indicator). Press **P** to paste and memorise the settings or **V** to cancel.

● **TEMPORARY TEMPERATURE VARIATION**

It is possible to vary set room temperature during automatic temperature control mode by acting on the + and – keys. Variations will be shown on the display.

When this function is used the symbol indicating the present level goes out and the indicator light corresponding to the relevant time slot starts flashing.

The new temperature will remain operative until the next value change, after which the programme will revert to normal settings.

NOTE: Immediately after setting the date and the day (section 2) a factory-set default programme is activated. This programme is given in the table below.

Standard Programme		
	from Monday to Friday	Saturday and Sunday
Low temp.	23:00+06:00	23:00+08:00
Comfort temp.	06:00+09:00	08:00+23:00
Low temp.	09:00+17:00	
Comfort temp.	17:00+23:00	

“MANUAL” TEMPERATURE CONTROL MODE

Pressing the  key enables manual operation of temperature control.

When manual mode is selected the  symbol appears on the display.

This mode excludes the daily/weekly timer and adjusts rooms temperature according to a standardised temperature setting (modified by pressing + or -).





SETTING THE TEMPERATURE

The control unit allows the user to set 5 basic temperatures in order to provide maximum comfort and maximum system efficiency.

● **HOT WATER TEMPERATURE**

This temperature may be set with either the Hot water or Hot water/Heating function enabled.

To set press the  key and the presently set temperature will appear on the display.

Now hold the  key down and press the – or + keys to modify the temperature setting as desired.

In addition to the displayed value the  symbol graphically illustrates the temperature setting.

Release the  key to memorise the new setting.

● **HEATING WATER TEMPERATURE**

This temperature may be set with either the Hot water/Heating or Heating function enabled.

To set press the  key and the presently set temperature will appear on the display.

Now hold the  key down and press the – or + keys to modify the temperature setting as desired.

In addition to the displayed value the  symbol graphically illustrates the temperature setting.

Release the  key to memorise the new setting.

Should the boiler be equipped with an outdoor sensor, the values being displayed and set are outdoor temperature and heating water temperature.

● **STANDARD ROOM TEMPERATURE**

Sets the standard Manual temperature in either the Heating or Hot water/Heating modes.

Press the – or + keys to set the temperature as desired: the display shows the presently set temperature. Five (5) seconds after the end of the setting procedure the data is automatically memorised and the display reverts back to the clock.

● **COMFORT ROOM TEMPERATURE**

This temperature may be set with either the Heating or Hot water/Heating function enabled.

To set press the  key: the presently set temperature will appear on the display.

Now hold the  key down and press the – or + keys to modify the temperature setting as desired.

Release the  key to memorise the new setting.

● **LOW ROOM TEMPERATURE**

This temperature may be set with either the Hot water/Heating or Heating function enabled.









To set press the  key: the presently set temperature will appear on the display.

Now hold the  key down and press the - or + keys to modify the temperature setting as desired.

Release the  key to memorise the new setting.

VIEWING MAIN BOILER PARAMETERS

Press the  key repeatedly to view the main boiler parameters (illustrated below) in sequence.
Displayed parameters:

- effective heating water temperature (flashing  symbol)
- effective hot water temperature (flashing  symbol)
- room temperature setting according to present value (flashing  symbol)
- outdoor temperature (flashing  symbol).
If there is no outdoor sensor the display shows "--:--".
- system water pressure (flashing  symbol)
If there is no water pressure indicator the display shows "--:--".

The appearance of the  symbol on the display shows that the user has requested Hot Water or Heating.



RE-ESTABLISHING FACTORY SETTINGS AND CONTROL RESET

You may wish to re-establish the settings made at the factory: to do so press the  key for 10 seconds and the message “**Fab**” will appear on the display.

Going through this procedure resets the following parameters:

- standard temperature 20°C
- comfort temperature: 20°C
- low temperature: 17°C
- standard timer programme

Pressing key **R** cancels all user-set data.

In this case it will be necessary to reset all the parameters starting from section 1.

ERROR MESSAGES

In the event of a boiler malfunction the control unit governs the warning signals and is used to reset normal operation.

Warnings take the form of a code letter and a number (**E XX**) followed by the  symbol. This symbol is displayed constantly where the anomaly can be reset and flashes when it cannot. To reset a resettable anomaly and restore normal boiler operation press key **A**.

MESSAGE DISPLAYS

Code	E02	THERMOSTAT LIMIT (IF ANY)
Code	E04	NO WATER
Code	E05	HEATING SENSOR
Code	E06	DOMESTIC HOT WATER SENSOR
Code	E14	IGNITION FAULT



INSTALLER SETTINGS

The tasks in this section must only be carried out by qualified personnel.
Carrying out these procedures wrongly may damage the control unit and boiler or cause them to malfunction.

● **CONNECTING UP TO THE OUTDOOR TEMPERATURE SENSOR.**

The control unit can also be fitted with a sensor that monitors outdoor temperature.

The outdoor temperature reading utilised by the control unit may be supplied in one of two different ways:

- when the outdoor temperature sensor is connected to the boiler the temperature reading is sent from the boiler to the control unit.
- when the outdoor temperature sensor is connected directly to the control unit the reading is acquired and processed by the control unit directly.

If both are present the local sensor is ignored and the outdoor sensor connected to the boiler base is utilised.

This situation is highlighted by the appearance of error message **E67**.

To connect the outdoor sensor to the control unit use the S.EXT connection on the terminal block.

With the outdoor sensor connected, pressing the  key shows the outdoor temperature and heating water temperature.

● **ENABLING REMOTE OPERATION**

The control unit has an input (**TEL +** and **-**) which allows connection of an optional control unit for distance operation.

Operating mode:

- **TEL** input open
The control unit operates as described in the handbook.
- **TEL** input closed

The control unit switches to remote mode, that is:

heating and hot water functions enabled, automatic temperature regulation according to timer programme with on-display information while upper display shows the **TEL** message in place of room temperature.

This mode persists until the user disables it by acting on the remote mode switch (**TEL** input open). Standard operating mode is then restored.

● **CLOCK SPEED CORRECTION**

Allows you to improve clock precision by increasing speed (should it run slow) or decreasing speed (should it run fast).

The entire correction procedure must be done with the control unit powered and connected to the boiler.

Clock correction:

Press key **R** and keep it pressed.

Press the **H/Day** key

Release the **R** key and wait for the display to show the "Hour" confirmation message.

The next two stages must be done within 5 seconds otherwise the procedure will be aborted (a change of one unit alters clock speed by 30 seconds a year).

Release the **H/day** key.

Press the **+** key to increase clock speed (an increase of one unit speeds up the clock by 30 seconds a year).

Press the **-** key to reduce clock speed (a decrease of one unit slows down the clock by 30 seconds a year).

Wait 5 seconds after the last modification to exit this function and recommence normal operation.



● **CORRECTING ROOM TEMPERATURE MEASUREMENT**

This allows the user to correct the room temperature detected by the control unit and adapt it to different user needs.

The entire correction procedure must be done with the control unit powered and connected to the boiler.

Room temperature correction:

Press key **R** and keep it pressed:

Press the  key.

Release key **R** and wait until the display shows the confirmation message “**Son**”

The next two stages must be done within 5 seconds otherwise the procedure will be aborted.

Release the  key.

Press the **+** key to introduce a positive correction (an increase of one unit means an increase of 0.1°C).

Press the **-** key to introduce a negative correction (a decrease of one unit means a decrease of 0.1°C).

Wait 5 seconds after the last modification to exit this function and recommence normal operation.

● **TEMPERATURE CONTROL: SELECTING THE FUNCTION MODE.**

These procedures allow the user to select one of the three possible temperature control modes.

The entire procedure must be done with the control unit powered and connected to the boiler.

Choosing a temperature control function mode:

Press key **R** and keep it pressed:

Press the  key.

Release key **R** and wait for the display to show the present temperature regulator mode (**tdi**, **ton** or **trc**).

The next two stages must be done within 5 seconds otherwise the procedure will be aborted.

Release the  key.

Press the  key to disable the temperature regulator, press  to select **ON - OFF** regulator mode

or press  to select modulating regulator mode.

The display will then show the **tdi**, **ton** or **trc** confirmation message.

Wait 5 seconds after the last modification to exit this function and recommence normal operation.



HYDRAULIC CONNECTION

Fit the supporting hooks and attach the assembly template, moving it up to the wall; fit all the pipes, starting with the end pipe fittings already mounted on the template: system supply, system return, cold water, hot water, any gas pipes and electric mains leads with room thermostat.

Once the pipes have been fitted, the end pipe fittings can be removed and ordinary caps fitted, ready for hydraulic tests to be carried out. The template can be removed or, if left in place, will be embedded in the wall once finishing operations have been completed (plaster and tiles); only the two supporting hooks will protrude from the wall, as well as an opening for the connections. Attach the boiler to the hooks through the holes at the back of the frame, push it up against the finished wall and fit the two lock nuts onto the hooks.

Make the necessary hydraulic connections using the pipes/tubes supplied, cutting them to the right length, depending on the distance between the fittings on the boiler and those on the template embedded in the wall.

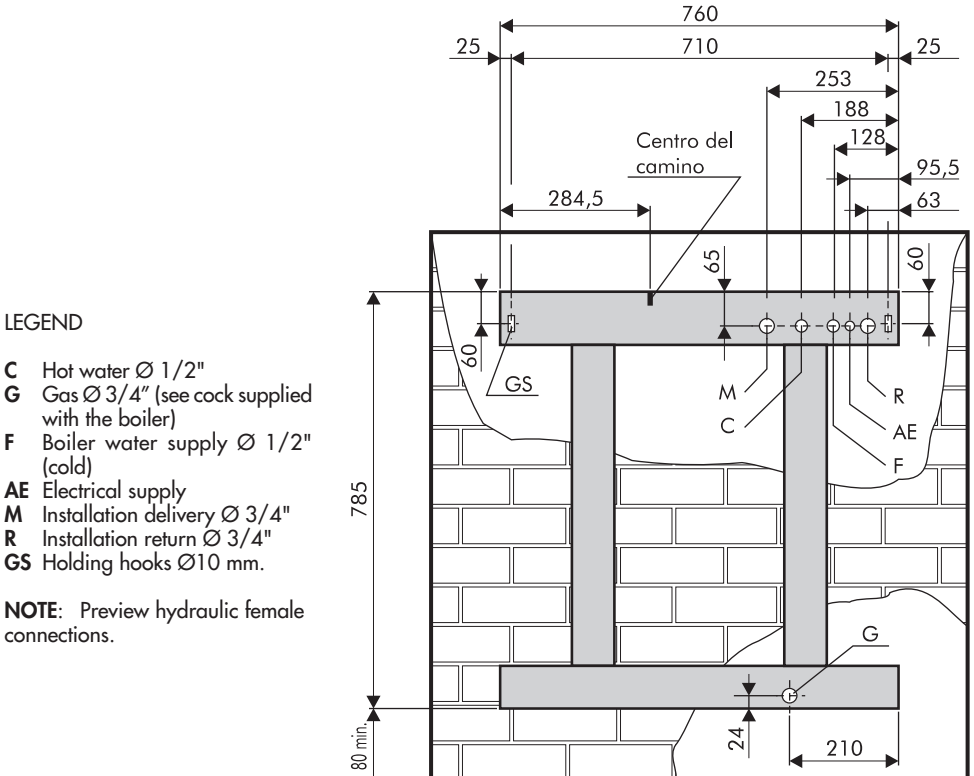



HYDRAULIC CIRCUIT

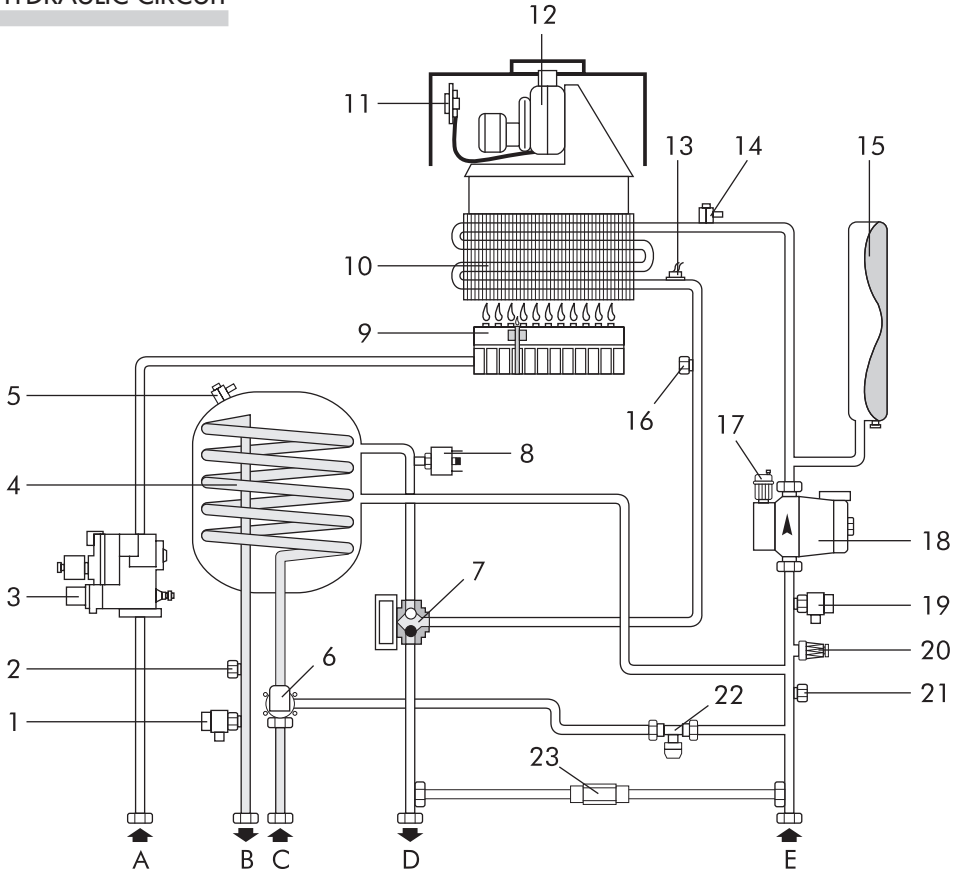

LEGEND

- | | | |
|---------------------------------------|--|--------------------------------------|
| A GAS | 7 3-way valve | 18 Circulating pump |
| B HOT WATER OUTLET | 8 Lack of water pressure switch | 19 Heating circuit drain cock |
| C COLD WATER INLET | 9 Burner | 20 Heating safety valve |
| D SYSTEM SUPPLY | 10 Fumes exchanger | 21 Hydrometer |
| E RETURN | 11 Fumes pressure switch | 22 Filling cock |
| 1 Hot water circuit drain cock | 12 Fumes fan | 23 By-pass |
| 2 Hot water detector | 13 Total safety thermostat | |
| 3 Gas valve | 14 Air purge manual valve | |
| 4 Instantaneous water-heater | 15 Expansion tank | |
| 5 Air purge manual valve | 16 Heating detector | |
| 6 Hot water pressure switch | 17 Air purge automatic valve | |



INSTALLATION

To be carried out by qualified personnel.

The installation must be in compliance with the stipulations of the law regarding the evacuation of combustion materials according to the REGULATIONS IN FORCE.

It is compulsory that the gas fumes evacuation is effected with a pipe of a diameter not less than that required by the boiler and that it comes connected to a flue pipe suitable for the capacity of the installation.

For connection of appliances to smoke conduits:

- they must be easy to dismantle;
- they must be sealed and of a material able to resist the products of combustion and their possible condensation;
- they must not have regulation devices (gate valves). If such devices are already in operation they must be eliminated;
- the connection itself must not project onto the inside of the flue pipe but stop before the internal face of the same.

GAS CONNECTION

Carry out the gas connection in accordance with the regulations in force.

The boiler must be connected to the installation with a rigid metal pipe or a flexible stainless steel pipe with continuous wall of the type approved. The flexible corrugated metal pipes must be installed in such a way that their length, in a state of maximum extension, is not greater than 2000 mm. The boilers are calibrated and tested to function with NATURAL GAS and LIQUID GAS, category II 2H3+, with rated pressure correspondent respectively to 20 mbars, 28/30 mbars and 37 mbars.

SETTING THE INSTALLATION IN SERVICE

- Proceed with the clearing out of air.
- Check that there are not any gas leaks (use a soapy solution or equivalent product).

STARTING UP

REFILLING INSTALLATION

Open the inlet cock (1) slowly until the system pressure indicated on the hydrometer (2) reaches 1.5 bar, then close it. Check that the 3-way valve (3) is in the manual position and that the automatic air purge valve (4) on the circulator has its cap loosened and is functioning properly. Then vent any air by means of the manual valve (5) on the boiler. Before ignition make sure that water pressure has not dropped beneath the initial head value.

For optimum boiler performance make sure that system pressure never drops below 1.5 bar.

SWITCHING ON

Open the gas cock. Turn the main wall-mounted electrical power switch to ON. Select the desired mode on the control unit (summer/winter/off), using the indicator lights as a guide.

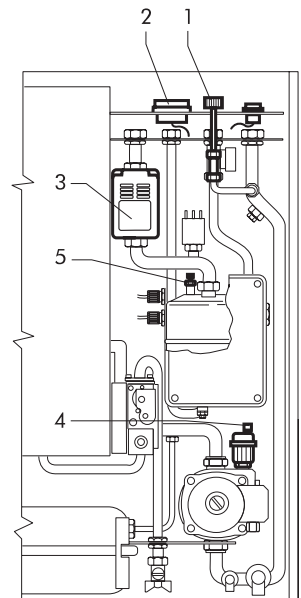



FLUE EXHAUST TYPES

The boiler must be installed and function outdoors.
For installation use only original LAMBORGHINI parts.

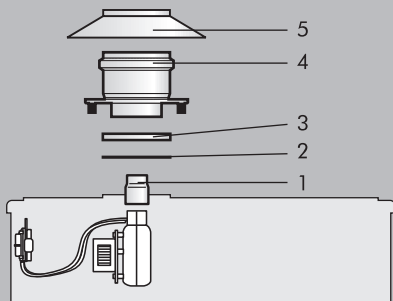

FAN-FORCED DRAUGHT FLUE EXHAUST KIT

To install the forced draught kit insert the funnel 1 (supplied with the boiler) in the fan. Insert the diaphragm 3 and the adhesive seal 2. Fix the flanged section 4 with the screws and insert the silicon hood 5. The latter must rest on the upper part of the boiler to prevent water infiltrating.

CONCENTRIC FLUE EXHAUST KIT

To install the concentric kit insert the funnel 1 (supplied with the boiler) in the fan. Insert the diaphragm 3 between the adhesive seal 2 and the 5 mm spacer 4. Fix the bend 5 with the screws and insert the supplied silicon hood 6. The latter must rest on the upper part of the boiler to prevent water infiltrating.

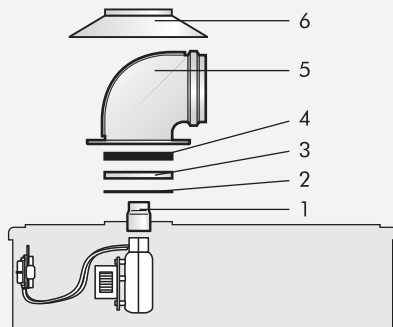

DOUBLE PIPE OUTLET KIT

To install the double pipe kit insert the funnel 1 (supplied with the boiler) in the fan. Insert the diaphragm 3 between the adhesive seal 2 and the 5 mm spacer 4. Fix the double pipe flue exhaust 5 with the screws and insert the supplied silicon hood 6. The latter must rest on the upper part of the boiler to prevent water infiltrating.

Warning: The boiler can only be fitted with the high double pipe flue exhaust kit.

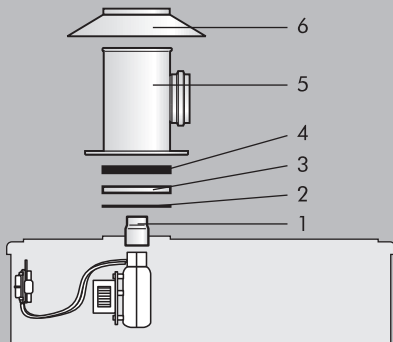



FLUE EXHAUST CONNECTION

FLUE EXHAUST CONNECTION TO FAN-FORCED DRAUGHT VERSION (B22)

The boiler is envisaged being **connected to a chimney** and/or a flue pipe with the following specification:

- of being sealed airtight, as with the connection to the chimney itself;
- of being of suitable material;
- of being connected within sight;
- for directional changes use 90° and 45° bends;
- of not having any intercepting devices;
- of having the axis at the entrance of the terminal section perpendicular to the opposite internal wall of the chimney;
- of being firmly fixed and sealed at the entrance, without protruding beyond the inner walls of the chimney;
- of receiving preferably one boiler only;
- of observing the local regulations in force.

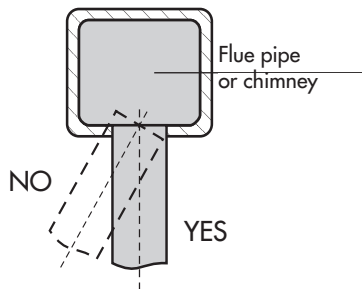

FLUE EXHAUST CONNECTION TO SEALED CHAMBER VERSION (C12-C32-C42)

The boiler is for combustion in a sealed chamber and does not require any special ventilation, it can be located also in small rooms, lumber-rooms, laboratories. In addition, there are various possibilities for combustion fumes evacuation and external air intake; basically the boiler is projected for two types of fumes evacuation/air intake:

- fumes evacuation/air intake concentric pipes system,
- fumes evacuation/air intake double pipes system.

In this way it is possible, by using suitable mounting kits, to connect boiler to concentric flues, ventilating flues, separate flues, etc.; some possible solutions are indicated on page 61.



FUMES EVACUATION/AIR INTAKE

- 1 Concentric flue pipe, from the terrace
- 2 Fan-forced draught (B22), from a flue pipe
- 3 Double pipe from separate flues
- 4 Concentric, connected to concentric flues
- 5 Fan-forced draught (B22), from the roof

For positioning and for distances of draught terminals from windows, doors, etc. see **regulations in force**.

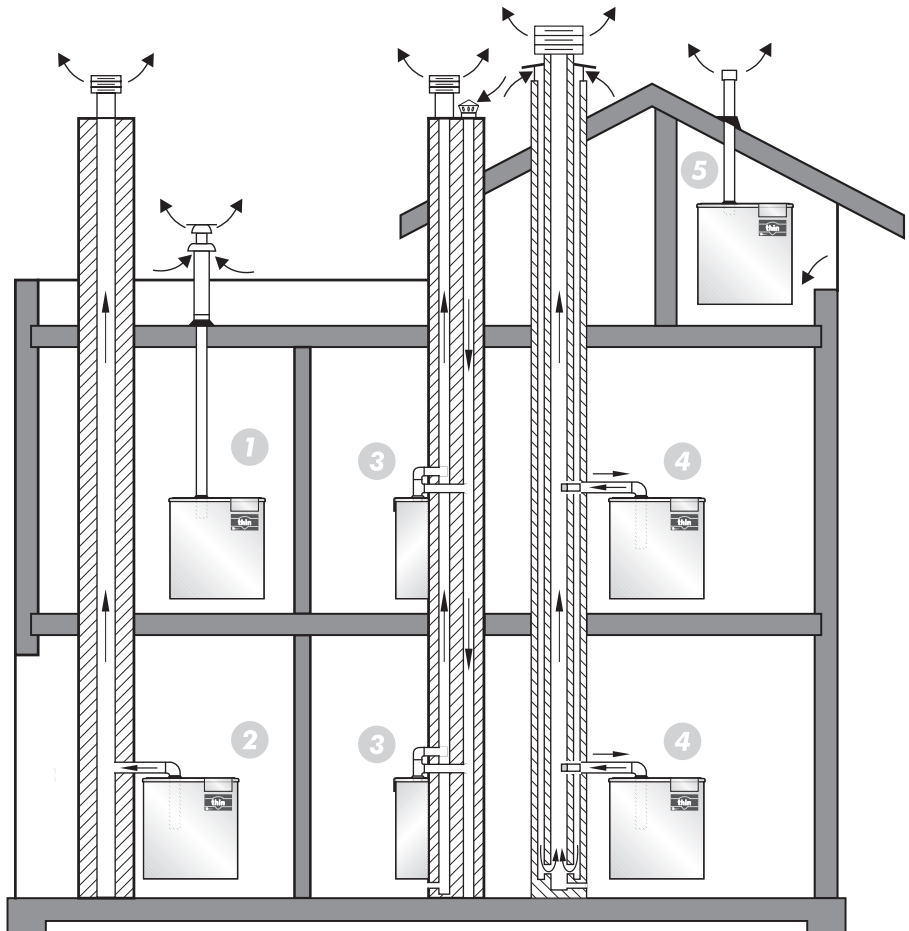



FLUE EXHAUST INSTALLATION

CONCENTRIC FLUE PIPE

Fit the concentric elbow pipe positioning it on the desired direction and insert on it the sealing gasket. Fit the air intake and flue pipes, observing the distances indicated on the installation scheme. The flue pipe should slope slightly outward.

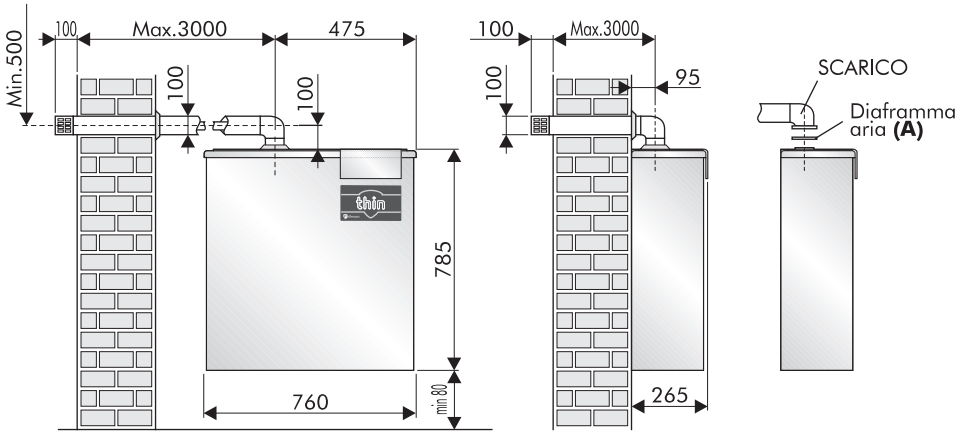

DOUBLE FLUE PIPE

FLUE PIPE FOR FAN-FORCED DRAUGHT VERSION (B22)

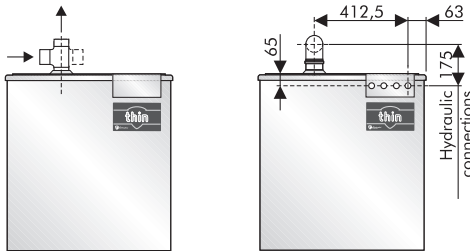

SELECTING THE RIGHT AIR DIAPHRAGM (A)

Flue exhaust for fan-forced draught version (B22) **Ø82 mm.**

Concentric flue exhaust from 0.35 m to 1 m **Ø82 mm.**

Concentric flue exhaust from 1 m to 3 m **Ø94 mm. STANDARD**

Double flue pipe (intake/outlet) **Ø94 mm. STANDARD**

FLUE EXHAUST FOR FAN-FORCED DRAUGHT VERSION (B22): max length 7.5 m
 CONCENTRIC FLUE EXHAUST: max length 3 m
 DOUBLE FLUE PIPE WITH $\text{Æ}82$ mm DIAPHRAGM: max length (intake+delivery) 6 m.
 DOUBLE FLUE PIPE WITH $\text{Æ}94$ mm DIAPHRAGM: max length (intake+delivery) 18 m.

Installing an elbow to connect the boiler to the chimney will cause a drop in pressure. The values set out in the table below indicate the necessary modifications to the length of the linear pipes.

TYPE OF INSTALLATION	ELBOW FITTED AT 90°	ELBOW FITTED AT 45°
Flue exhaust for fan-forced draught version (B22)	0,6 m	0,3 m
Concentric flue exhaust	1 m	0,5 m
Double flue pipe (intake/exhaust)	0,6 m	0,3 m

ATTENTION: Use only air intake/ fumes evacuation kit produced by Lamborghini Caloreclima.



ADJUSTMENTS

The boiler allows to adapt the heating thermal power (without involving the adjustment of the capacity available for the production of hot water) to the thermal need of the rooms to be heated.

When leaving the factory all boilers are set to 70% of their maximum output. To adapt the boiler to the thermal power needed by the plant it is necessary to carry out the following operations:

- Insert a manometer in the pressure tube (G)
- Electrically feed the gas valve with the boiler on in the WINTER position
- Adjust the heating potentiometer (1) located on the modulation card until the gas pressure required by the heating system capacity is reached (see pressure curves).

Should it be necessary to adjust the minimum and maximum regulation of the gas valve (preset at the factory) for the hot water supply, following operations should be carried out:

- remove the power supply contacts from the coil (E).
- power the gas valve with the boiler on in the SUMMER position and bleed off domestic hot water at the maximum flow rate (13 litres/min).
- turn the adjustment screw (D) all the way down without using any tools.
- loosen the locknut (B)
- use a wrench to turn the coil screw (A) until maximum gas pressure (values are given on page 43) is reached.
- tighten the locknut (B).
- undo the adjustment screw (D) until minimum gas pressure (values are given on page 43) is reached.
- reconnect the coil (E).

This task sets the boiler so that it suits the needs of the user.

NOTE: To carry out this adjustment it is necessary to use a water-column pressure gauge, connecting it to the pressure outlet (G).

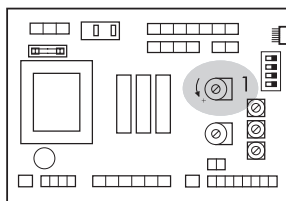

Modulation card

LEGEND

- A Max. capacity adjusting screw
- B Adjustment fixing counter-bolt
- C Spring
- D Min. capacity adjusting screw
- E Coil
- F Release spring
- G Pressure outlet
- H Control unit
- I Gas diaphragm (if any)
- L Compensation outlet

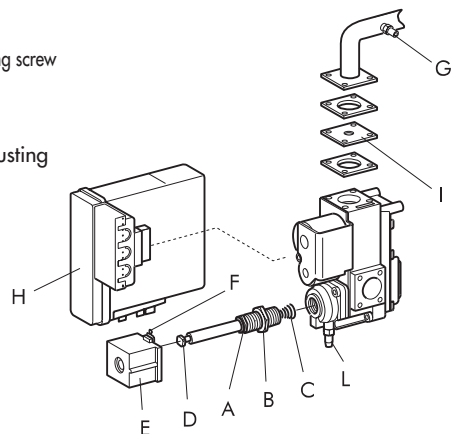



SWITCHING OFF

BOILER SWITCHED OFF FOR A PROLONGED PERIOD AND INSTALLED INSIDE

If the boiler should remain inactive at length close the gas cock and remove the electrical current from the appliance.

BOILER SWITCHED OFF FOR A PROLONGED PERIOD AND INSTALLED OUTSIDE.

Where there is risk of sub-zero temperatures and thus ice formation empty the hot water circuit and leave the heating circuit filled with the anti-freeze liquid.

NOTE: with a new boiler or after a long period of inactivity, one can check for the locking of the circulating pump. In this case it is necessary to unscrew the front stopper and make the rotor shaft rotate with a screwdriver.

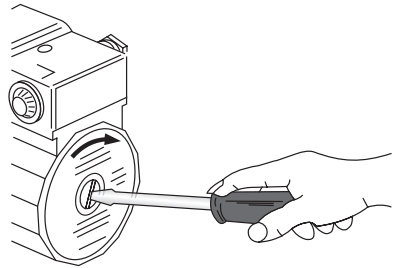

MAINTENANCE

The following operations should only be carried out by qualified personnel; then please call our after-sale service:



SEASONAL CHECKS

Before the beginning of the winter season the system, equipment and chimney should be given a general check. Check the following:

- Hydraulic system pressure;
- Hydraulic system efficiency;
- regulation and safety thermostat operation;
- circulation pump operation;
- combustion performance (CO-CO₂);
- fume exhaust;
- condition of burner, clean where necessary;
- effective gas circuit seal and proper operation of gas valve.



OPERATION WITH DIFFERENT TYPES OF GAS

CONVERSION FROM NATURAL GAS TO LIQUID GAS

Proceed with burner jets replacement. Insert the diaphragm (I) included in the kit. Also replace the spring (C) under the rod of the coil (E), checking that it is assembled the right way round. Switch the bridge on the modulation board from NATURAL GAS to the B-P position.

Then adjust as indicated in the paragraph "ADJUSTMENTS", page 63.

For jets diameter and operating gas pressure see the table here-under.

Gas type	Jets pressure mbars		Delivery m ³ /h	Burner jets Ø mm.	L.C.V. kcal/h	Gas diaphragm (M) Ø
	min.	max.				
NATURAL GAS (G20-20mbars)	2	11	3,06	1,25	8.550	-
LIQUID GAS B (G30-28/30mbars)	5	25	0,89	0,77	29.330	5,4
LIQUID GAS P (G31-37mbars)	6,2	32	1,17	0,77	22.360	5,4

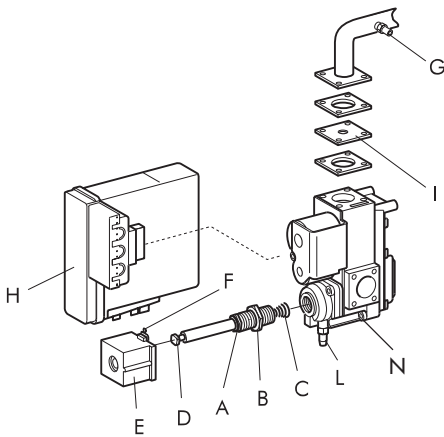

LEGEND

- A** Max. capacity adjusting screw
- B** Adjustment fixing counter-bolt
- C** Spring
- D** Min. capacity adjusting screw
- E** Coil
- F** Release spring
- G** Pressure outlet
- H** Control unit
- I** Gas diaphragm (if any)
- L** Compensation outlet
- N** Slow ignition (RLA)

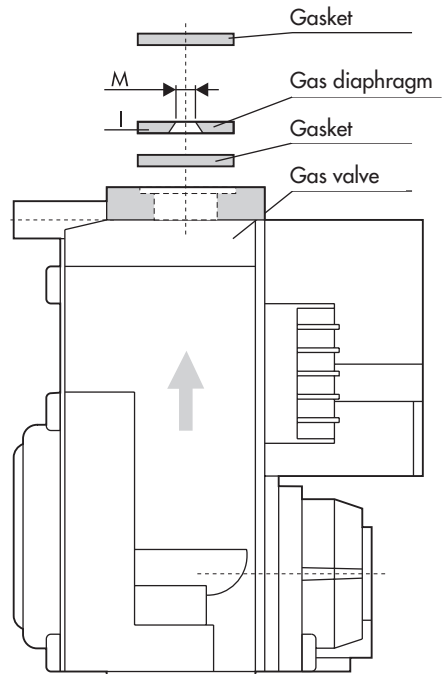



ANTI-FREEZE KIT (ON REQUEST)

The THIN boiler is fitted as standard with an anti-freeze device that protects the hydraulic circuit. This device is tripped when the temperature falls to about 6°C. The hot water circuit can be provided with even better protection by installing an ANTI-FREEZE KIT which starts functioning at 4°C.

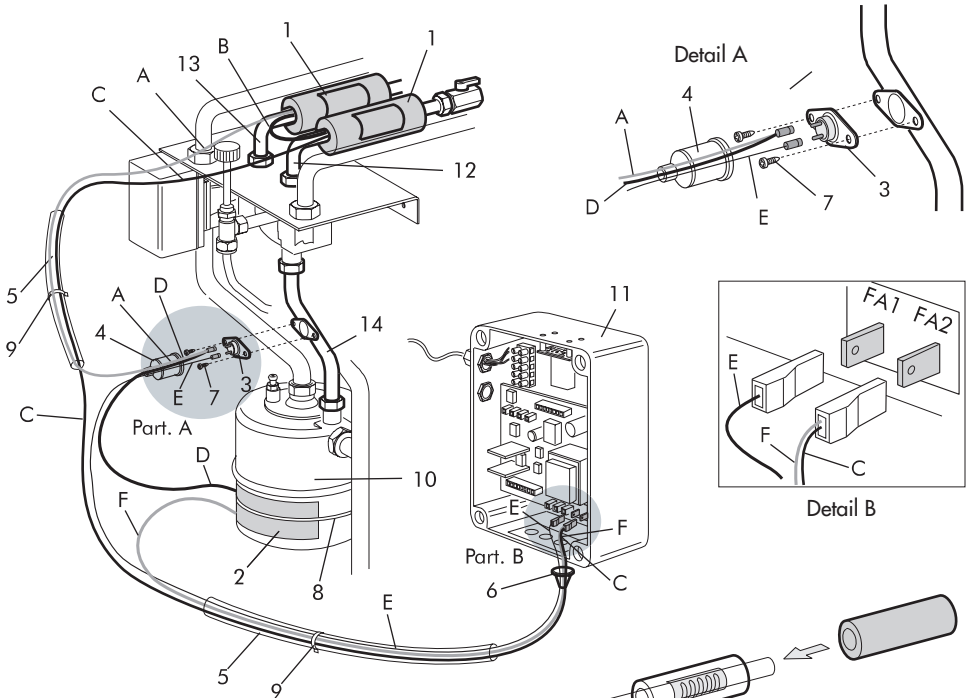

ANTI-FREEZE KIT components

- 1 Adhesive element 72x42-230V-12 W
- 2 Adhesive element 200x53-230V-30 W
- 3 Anti-freeze thermostat 4°C -14°C
- 4 Silicon insulating hood
- 5 Insulating sheath internal $\text{Æ}16 \text{ mm} \times 70 \text{ mm}$
- 6 Wire plug
- 7 Self-tapping screws
- 8 Holder strap
- 9 Element wire ring clip
- 10 Rapid exchanger
- 11 Electric board
- 12 Cold water inlet
- 13 Hot water outlet
- 14 Hot water inlet

INSTALLING THE ELEMENTS

Apply the elements 1 and 2; fit them the right way round as illustrated. Fix the thermostat 3 onto the base located on the hot water inlet pipe using the screws 7. Insert the electrical wires in the junction box making sure that the supplied wire plug 6 is positioned correctly. Connect the wires to the FA1/FA2 terminals as illustrated (see detail B).



FAULT-FINDING CHART

FAULT	CAUSE	RIMEDY
1 NO IGNITION	A. Gas cock closed B. "Off" button locked C. No flame detection D. No ignition spark E. Air inside pipes F. Safety thermostat intervention G. Water not circulating H. Boiler water temperature higher than figure set on the regulation thermostat	A. Open gas cock B. Reset by pressing C. Nautral and phase inverted D. Call technical service E. Repeat ignition F. Press reset button G. Adjust boiler pressure and check circulating pump H. Adjust thermostat setting on desired temperature.
2 CRACKLING IGNITION	A. Irregular flame B. Insufficient or wrongly adjusted gas delivery	A. Call technical service B. Call technical service
3 SMELL OF GAS	A. Leak in pipes circuit (inside and outside boiler)	A. Check for possible leaks in the external and external pipes. Call technical service
4 SMELL OF UNBURNT GAS INCOMBUSTE AND BAD BURNER COMBUSTION	A. Flue section or height with joint not suitable for the boiler B. Excessive gas consumption - combustion state is imperfect C. Flames tend to move away D. Flames have yellow tips	A. Replace unsuitable components. B. Adjust gas delivery on the modulating device. C. Check/adjust gas valve pressure stabilizer D. Check that air volutes and Venturi cones of the burner are clean. If items A-B-C-D have been checked with negative result call technical service
5 CONDENSATION IN THE BOILER	A. Flue section or height not suitable (excessive size) B. Boiler operating at low temperature	A. Replace unsuitable components. B. Adjust boiler thermostat at a higher temperature and check if air intake pipe/flue exhaust connection is correct.
6 COLD RADIATORS IN WINTER	A. Summer-winter switch in summer WINTER position B. Room thermostat adjusted too low or faulty C. System or radiators closed D. Circulating pump blocked E. 3-way valve faulty	A. Place it in winter position B. Adjust thermostat at a higher temperature or replace it. C. Check if system gate valves and radiator cocks are opened. If item C has been checked with negative result call technical service D. Unblock with a screwdriver and check electrical supply E. Check electricity supply
7 POOR HOT WATER SUPPLY	A. Priority thermostat temperature set too low B. 3-way valve faulty	A. Adjust priority thermostat at a higher temperature or replace it B. Check for correct power supply and correct positioning of valve body

BRUCIATORI
CALDAIE MURALI E TERRA A GAS
GRUPPI TERMICI IN GHISA E IN ACCIAIO
GENERATORI DI ARIA CALDA
TRATTAMENTO ACQUA
CONDIZIONAMENTO

SEI
0444 351044

Le illustrazioni e i dati riportati sono indicativi e non impegnano. La LAMBORGHINI si riserva il diritto di apportare senza obbligo di preavviso tutte le modifiche che ritiene più opportuno per l'evoluzione del prodotto.

The illustrations and data given are indicative and are not binding on the manufacturer. LAMBORGHINI reserves the right to make those changes, considered necessary, for the improvement of the product without forwaming the customer.

Las ilustraciones y los datos son indicativos y no comprometen. LAMBORGHINI se reserva el derecho de realizar sin preaviso todas las modificaciones que estime oportuno para la evolución del producto.

As ilustrações e os dados existentes são indicativos e não compromissivos. A LAMBORGHINI reserva-se o direito de efectuar, sem a obrigação de pré-aviso, todas as modificações que considerar necessárias para a melhoria do produto.

LAMBORGHINI CALOR S.p.A.
VIA STATALE, 342
44040 DOSSO (FERRARA)
ITALIA
TEL. ITALIA 0532/359811 - EXPORT 0532/359913
FAX ITALIA 0532/359952 - EXPORT 0532/359947



Lamborghini
CALORECLIMA

AZIENDA CERTIFICATA ISO 9001

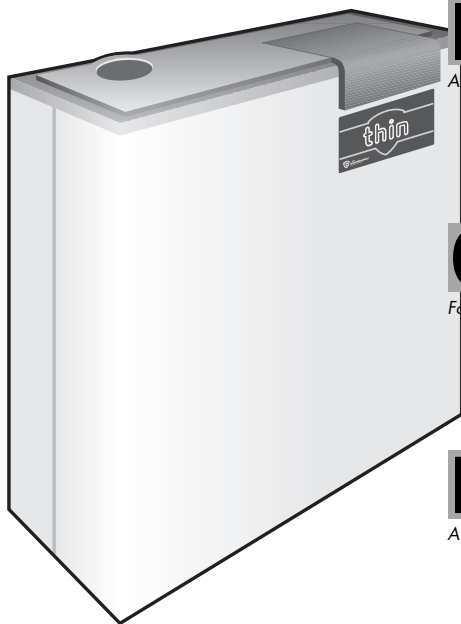

IT CALDAIA MURALE A GAS
ALTO RENDIMENTO - MODULANTE
MANUALE PER L'UTENTE **2**

Alla cortese attenzione del sig. INSTALLATORE:

Consegnare il presente manuale d'uso all'UTENTE

GB WALL-HUNG GAS BOILER
FOR HIGH EFFICIENCY - MODULATING
USER MANUAL **16**

For the attention of the INSTALLATION TECHNICIAN:

make sure that this manual is handed over to the USER

ES CALDERA MURAL A GAS
ALTO RENDIMIENTO - MODULANTE
MANUAL PARA EL USUARIO **28**

A la atención del sr. INSTALADOR:

Entregar el presente manual para el uso al USUARIO

PT CALDEIRA DE PAREDE A GÁS
ALTO RENDIMIENTO - MODULANTE
MANUAL DO UTENTE **42**

Atenção do Sr. INSTALADOR:

Entregue este manual de uso ao UTENTE



thin 24 MCS W TOP U/IT



INDEX	PAGE
GENERAL INSTRUCTIONS	17
INSTRUCTIONS FOR THE USE	18
CHECKS AND MAINTENANCE	19
SETTING THE TIME/DAY OF THE WEEK	20
MODES	20
"AUTOMATIC" TEMPERATURE CONTROL MODE	21
"MANUAL" TEMPERATURE CONTROL MODE	22
SETTING THE TEMPERATURE	22
VIEWING MAIN BOILER PARAMETERS	23
RE-ESTABLISHING FACTORY SETTINGS AND CONTROL RESET	24
ERROR MESSAGES	24
INSTALLER SETTINGS	25
FAULT-FINDING CHART	27

THIN series wall hung boilers have passed European type examinations and comply with the most stringent safety and performance specifications.



Dear User...

...you have entered into possession of a product that is the result of a careful design and advanced production systems ensuring high-top operational reliability and saving. Read carefully this guide in order to know any detail concerning the product's operation system.

The "LAMBORGHINI SERVICE" after-sales centres are at your disposal to ensure QUALIFIED MAINTENANCE and PROMPT SERVICE.

LAMBORGHINI CALORECLIMA

For the installation and positioning of the boiler:
CAREFULLY OBSERVE THE LOCAL REGULATIONS IN FORCE



GENERAL INSTRUCTIONS

- This booklet constitutes an integral and essential part of the product and should be preserved for any further consultation.
Read carefully the instructions contained in this booklet as they provide important directions regarding the operation of the appliance, allowing a great saving in its use and maintenance.
- If the appliance is sold or transferred to other people or if you move house and leave your apartment, ensure that the manual remains with the appliance so that it can be used by the new owner.
- This appliance should be destined only for the use for which it has been expressly envisaged.
Any other use is to be considered improper and therefore dangerous.
The manufacturer cannot be considered responsible for any damages caused from improper, erroneous or unreasonable use.
- Do not touch the parts of the boiler which during the operation become overheated.
These parts can be dangerous for children or inexperienced persons.
- Do not obstruct the inlet or dissipation screens.
- Do not make the boiler wet with splashes of water or other liquids.
- Do not rest any object upon the boiler.
- Use of the boiler is prohibited for children or the inexperienced.
- Do not carry out any cleaning of the boiler with inflammable substances.
- Do not deposit containers of inflammable substances in the location where the boiler is situated.
- In the presence of the risk of freezing suitable provisions must be taken which are not however the concern of the boiler manufacturer
- **As the boiler has hot spots it is forbidden to leave any object which might explode when exposed to heat.**

ALL INSTALLATION, MAINTENANCE AND GAS CONVERSION OPERATIONS MUST BE CARRIED OUT BY AUTHORISED SKILLED TECHNICIANS.

To ensure that boiler is installed correctly and that it functions properly, we recommend that only Lamborghini accessories and spare parts be used.

On noticing the smell of gas do not touch any electric switch. Open doors and windows, shut off the gas cocks.

WARNING: The boiler must be electrically fed even when it is not in use.



INSTRUCTIONS FOR THE USE

- In case of breakdown and/or malfunctioning of the appliance, disconnect it avoiding any attempt of repair or direct intervention.
Call exclusively professionally qualified personnel.
Any repair must be carried out by an after-sale service centre "LAMBORGHINI SERVICE" authorised by the manufacturing firm, and using original replacements exclusively.
Non-observance of the above could compromise the guarantee and the safety of the appliance.
In order to guarantee the efficiency of the appliance and its proper operation it is indispensable to keep to the manufacturer's directions, by ensuring the periodical servicing of the appliance is carried out by professionally qualified personnel.
- Check the system hydraulic pressure during the first ignition and then periodically by using the hydrometer. Check that readings for the system when cold are within manufacturer-specified limits. Should any falls-off in pressure be noticed contact a qualified technician.
- After each reopening of the gas cock wait a few minutes before restarting the boiler
- As soon as one decides not to use the appliance further, one should take care to render innocuous those parts liable to be potential sources of danger.
- As soon as one decides to disconnect the boiler definitively, one should ask qualified personnel to effect the related works, then ensure that the main supplies have been disconnected.
- For the power supply to the boiler the use of adaptors, multiple sockets or extensions is not permitted. The use of a switch as indicated by the safety regulations in force must be provided.
- The use of appliances which utilise electrical energy involve the observation of fundamental rules which are:
 - a) not to touch the appliance with parts of the body which are wet or when in bare feet;
 - b) not to pull electrical wires;
 - c) not to expose the appliance to the atmospheric agents;
 - d) not to allow use of the appliance to children or the inexperienced.
- In the case of structural work positioned near the flue pipe, turn off the boiler and at the end of the work ensure that the efficiency of the flue exhaust is verified by qualified personnel.
- On noticing the smell of gas do not touch any electric switch. Open all doors and windows. Shut off the gas cocks and call qualified personnel.



CHECKS AND MAINTENANCE

- Before starting up the boiler ask qualified personnel "LAMBORGHINI SERVICE" to check:
 - a) that the data on the information plate corresponds to that required by the gas, electrical and water supply networks;
 - b) that the pipes which branch off from the boiler are lined with suitable thermally-insulated sheathing;
 - c) the proper functioning of the flue pipe;
 - d) that the comburent air flow and the fumes evacuation take place properly in accordance with the regulations in force;
 - e) that correct aeration and maintenance are possible in case of installation in the furniture.
- Ensure that the installer has connected the boiler safety discharge to a waste. In the case of the contrary the intervention of the safety valves could flood the premises and the manufacturer would not be held responsible for this.
- Ensure that the piping of the installation is not used as an earth outlet for other installations; beyond not being ideal for such a use it could in short bring serious damage to the other appliances connected to it.
- Ask qualified personnel "LAMBORGHINI SERVICE" to check:
 - a) the internal and external tightness of the gas system;
 - b) that the gas delivery is that required by the boiler output;
 - c) that the type of gas is suitable for the boiler;
 - d) that the pressure of gas supply is within the values stated on the boiler plate;
 - e) that the gas installation is the correct size and equipped with all the safety and checking devices prescribed by the current regulations.
- Ask periodically to check the proper functioning and the good state of the flue exhaust.
- Ensure that the electrical system has been confirmed by qualified personnel to be adequate for the power required by the appliance itself.
- The electricity supply cable must not be replaced by the user, but by qualified personnel only.
- The electrical safety of the appliance is attained only if the same has been connected to an effective system earthed in accordance with the current regulations. The verification of this fundamental prerequisite should be made by qualified persons as the manufacturer will not be responsible for damage caused by the lack of adequate earthing of the installation.



SETTING THE TIME/DAY OF THE WEEK

You can set the clock time and the day of the week in any mode.

To begin setting press the **H/Day** key once.

The minute figures will then start flashing.

Press the **+** and **-** keys to set the minutes and then press **H/Day** again to confirm.

The hour figures on the display will now flash.

Press the **+** and **-** keys to set the hour and then press **H/day** again to confirm.





Once you have completed setting the clock time the day indicator  will begin flashing.

The  indicators signal the sequence of days from Monday to Sunday (1 = Monday, 2 = Tuesday etc.)
Press the **+** and **-** keys to select the desired day then press **P** to memorise the settings.

MODES

The control unit runs the boiler by enabling or disabling each individual mode according to requirements.



Press the  key repeatedly and the following modes will be enabled in sequence: OFF, Hot water, Hot water/Heating and Heating.

- **OFF MODE ("OFF" APPEARS ON THE DISPLAY)**
This mode allows you to disable the Hot water and Heating functions, yet keeps the boiler safety functions operative.
In this mode any request for hot water and any request to switch on the heating circuit will be ignored.
- **"HOT WATER" MODE ( SYMBOL DISPLAYED)**
This function enables the boiler for production of hot water.
When this function is enabled it is possible to adjust the hot water to the desired temperature.
In this mode, any request to switch on the heating circuit will be ignored.
- **"HOT WATER/HEATING" MODE ( AND  SYMBOLS DISPLAYED)**
This mode provides both hot water and heating, operated automatically according to requirements.
- **"HEATING" FUNCTION ( SYMBOL DISPLAYED)**
This mode enables the boiler for activation of the heating circuit in "Automatic" or "Manual".
When this mode is selected you can adjust heating water temperature and set the on/off times to be used in automatic mode.
In this mode, any request for the production of hot water will be ignored.







"AUTOMATIC" TEMPERATURE CONTROL MODE



The control unit has a daily/weekly timer that automatically adjusts room temperature to "comfort" or "low temperature" values over a 24 hour period, with independent settings for each of the seven days.

To enable automatic operation press the  key and the  symbol will be displayed. Hourly programming of temperature values is only permitted with the Heating or Hot water/Heating functions enabled.

● HOURLY PROGRAMMING OF TEMPERATURE VALUES

Press key **V** to select the desired day on the  indicators. The display will then show the programme graph for the selected day by displaying the "indicator lights" next to the "comfort" level. To modify these settings press **P** within 5 seconds. The time "00:00" will now appear on the display and the indicator light corresponding to that time will begin to flash. Press the **+** and **-** keys to increase or decrease the time in 30-minute steps.

The  and  symbols show the present value of the indicator light ( comfort temperature level and  low temperature level)

Select the desired value by acting on the  (comfort temperature level) and  (low temperature level) keys. The indicator light will take on the desired value and programming will advance by one step: the next indicator light to be programmed will then flash. Once programming is over press **P** to memorise settings or **V** to cancel the modifications. The timer can memorise up to 48 daily temperature value changes.

● COPYING HOURLY PROGRAMMING

To speed up programming, you can "paste" the settings for a specific day onto another day. Press **V** to select the day from which you wish to copy the settings. Press the **Copy** key within 5 seconds to copy and then press the **+** and **-** keys to select the page onto which you intend to "paste" them (the "destination" day is indicated by a flashing  indicator). Press **P** to paste and memorise the settings or **V** to cancel.

● TEMPORARY TEMPERATURE VARIATION

It is possible to vary set room temperature during automatic temperature control mode by acting on the **+** and **-** keys. Variations will be shown on the display.

When this function is used the symbol indicating the present level goes out and the indicator light corresponding to the relevant time slot starts flashing. The new temperature will remain operative until the next value change, after which the programme will revert to normal settings.



NOTE: Immediately after setting the date and the day (section 2) a factory-set default programme is activated. This programme is given in the table below.

Standard Programme		
	from Monday to Friday	Saturday and Sunday
Low temp.	23:00+06:00	23:00+08:00
Comfort temp.	06:00+09:00	08:00+23:00
Low temp.	09:00+17:00	
Comfort temp.	17:00+23:00	

“MANUAL” TEMPERATURE CONTROL MODE

Pressing the  key enables manual operation of temperature control.

When manual mode is selected the  symbol appears on the display. This mode excludes the daily/weekly timer and adjusts rooms temperature according to a standardised temperature setting (modified by pressing + or -).

SETTING THE TEMPERATURE

The control unit allows the user to set 5 basic temperatures in order to provide maximum comfort and maximum system efficiency.

● **HOT WATER TEMPERATURE**

This temperature may be set with either the Hot water or Hot water/Heating function enabled.

To set press the  key and the presently set temperature will appear on the display.

Now hold the  key down and press the - or + keys to modify the temperature setting as desired.

In addition to the displayed value the  symbol graphically illustrates the temperature setting.

Release the  key to memorise the new setting.

● **HEATING WATER TEMPERATURE**

This temperature may be set with either the Hot water/Heating or Heating function enabled.

To set press the  key and the presently set temperature will appear on the display.

Now hold the  key down and press the - or + keys to modify the temperature setting as desired.

In addition to the displayed value the  symbol graphically illustrates the temperature setting.



Release the  key to memorise the new setting.
Should the boiler be equipped with an outdoor sensor, the values being displayed and set are outdoor temperature and heating water temperature.

● **STANDARD ROOM TEMPERATURE**

Sets the standard Manual temperature in either the Heating or Hot water/Heating modes.
Press the – or + keys to set the temperature as desired: the display shows the presently set temperature.
Five (5) seconds after the end of the setting procedure the data is automatically memorised and the display reverts back to the clock.

● **COMFORT ROOM TEMPERATURE**

This temperature may be set with either the Heating or Hot water/Heating function enabled.

To set press the  key: the presently set temperature will appear on the display.

Now hold the  key down and press the – or + keys to modify the temperature setting as desired.

Release the  key to memorise the new setting.

● **LOW ROOM TEMPERATURE**

This temperature may be set with either the Hot water/Heating or Heating function enabled.





To set press the  key: the presently set temperature will appear on the display.

Now hold the  key down and press the – or + keys to modify the temperature setting as desired.

Release the  key to memorise the new setting.

VIEWING MAIN BOILER PARAMETERS

Press the  key repeatedly to view the main boiler parameters (illustrated below) in sequence.
Displayed parameters:

- effective heating water temperature (flashing  symbol)
- effective hot water temperature (flashing  symbol)
- room temperature setting according to present value (flashing  symbol)
- outdoor temperature (flashing  symbol).
If there is no outdoor sensor the display shows “-:-”.
- system water pressure (flashing  symbol)
If there is no water pressure indicator the display shows “-:-”.



The appearance of the  symbol on the display shows that the user has requested Hot Water or Heating.

RE-ESTABLISHING FACTORY SETTINGS AND CONTROL RESET

You may wish to re-establish the settings made at the factory: to do so press the  key for 10 seconds and the message "**Fab**" will appear on the display.

Going through this procedure resets the following parameters:

- standard temperature 20°C
- comfort temperature: 20°C
- low temperature: 17°C
- standard timer programme

Pressing key **R** cancels all user-set data.

In this case it will be necessary to reset all the parameters starting from section 1.

ERROR MESSAGES

In the event of a boiler malfunction the control unit governs the warning signals and is used to reset normal operation.

Warnings take the form of a code letter and a number (**E XX**) followed by the  symbol. This symbol is displayed constantly where the anomaly can be reset and flashes when it cannot.

To reset a resettable anomaly and restore normal boiler operation press key **A**.

MESSAGE DISPLAYS

Code	E02	THERMOSTAT LIMIT (IF ANY)
Code	E04	NO WATER
Code	E05	HEATING SENSOR
Code	E06	DOMESTIC HOT WATER SENSOR
Code	E14	IGNITION FAULT



INSTALLER SETTINGS

The tasks in this section must only be carried out by qualified personnel.
Carrying out these procedures wrongly may damage the control unit and boiler or cause them to malfunction.

● **CONNECTING UP TO THE OUTDOOR TEMPERATURE SENSOR.**

The control unit can also be fitted with a sensor that monitors outdoor temperature.

The outdoor temperature reading utilised by the control unit may be supplied in one of two different ways:

- when the outdoor temperature sensor is connected to the boiler the temperature reading is sent from the boiler to the control unit.
- when the outdoor temperature sensor is connected directly to the control unit the reading is acquired and processed by the control unit directly.

If both are present the local sensor is ignored and the outdoor sensor connected to the boiler base is utilised.

This situation is highlighted by the appearance of error message **E67**.

To connect the outdoor sensor to the control unit use the S.EXT connection on the terminal block.

With the outdoor sensor connected, pressing the  key shows the outdoor temperature and heating water temperature.

● **ENABLING REMOTE OPERATION**

The control unit has an input (**TEL +** and **-**) which allows connection of an optional control unit for distance operation.

Operating mode:

- **TEL** input open
The control unit operates as described in the handbook.
- **TEL** input closed

The control unit switches to remote mode, that is:

heating and hot water functions enabled, automatic temperature regulation according to timer programme with on-display information while upper display shows the **TEL** message in place of room temperature.

This mode persists until the user disables it by acting on the remote mode switch (**TEL** input open). Standard operating mode is then restored.

● **CLOCK SPEED CORRECTION**

Allows you to improve clock precision by increasing speed (should it run slow) or decreasing speed (should it run fast).

The entire correction procedure must be done with the control unit powered and connected to the boiler.

Clock correction:

Press key **R** and keep it pressed.

Press the **H/Day** key

Release the **R** key and wait for the display to show the "**Hour**" confirmation message.

The next two stages must be done within 5 seconds otherwise the procedure will be aborted (a change of one unit alters clock speed by 30 seconds a year).

Release the **H/day** key.

Press the **+** key to increase clock speed (an increase of one unit speeds up the clock by 30 seconds a year).

Press the **-** key to reduce clock speed (a decrease of one unit slows down the clock by 30 seconds a year).

Wait 5 seconds after the last modification to exit this function and recommence normal operation.



● **CORRECTING ROOM TEMPERATURE MEASUREMENT**

This allows the user to correct the room temperature detected by the control unit and adapt it to different user needs.

The entire correction procedure must be done with the control unit powered and connected to the boiler.

Room temperature correction:

Press key **R** and keep it pressed:

Press the  key.

Release key **R** and wait until the display shows the confirmation message “**Son**”

The next two stages must be done within 5 seconds otherwise the procedure will be aborted.

Release the  key.

Press the **+** key to introduce a positive correction (an increase of one unit means an increase of 0.1°C).

Press the **-** key to introduce a negative correction (a decrease of one unit means a decrease of 0.1°C).

Wait 5 seconds after the last modification to exit this function and recommence normal operation.

● **TEMPERATURE CONTROL: SELECTING THE FUNCTION MODE.**

These procedures allow the user to select one of the three possible temperature control modes.

The entire procedure must be done with the control unit powered and connected to the boiler.

Choosing a temperature control function mode:

Press key **R** and keep it pressed:

Press the  key.

Release key **R** and wait for the display to show the present temperature regulator mode (**tdi**, **ton** or **trc**).

The next two stages must be done within 5 seconds otherwise the procedure will be aborted.

Release the  key.

Press the  key to disable the temperature regulator, press  to select **ON - OFF** regulator mode

or press  to select modulating regulator mode.

The display will then show the **tdi**, **ton** or **trc** confirmation message.

Wait 5 seconds after the last modification to exit this function and recommence normal operation.



FAULT-FINDING CHART

FAULT	CAUSE	REMEDY
1 NO IGNITION	A. Gas cock closed B. "Off" button locked C. No flame detection D. No ignition spark E. Air inside pipes F. Safety thermostat intervention G. Water not circulating H. Boiler water temperature higher than figure set on the regulation hermostat	A. Open gas cock B. Reset by pressing C. Neutral and phase inverted D. Call technical service E. Repeat ignition F. Press reset button G. Adjust boiler pressure and check circulating pump H. Adjust thermostat setting on desired temperature.
2 CRACKLING IGNITION	A. Irregular flame B. Insufficient or wrongly adjusted gas delivery	A. Call technical service B. Call technical service
3 SMELL OF GAS	A. Leak in pipes circuit (inside and outside boiler)	A. Check for possible leaks in the external and external pipes. Call technical service
4 SMELL OF UNBURNT GAS AND BAD BURNER COMBUSTION	A. Flue section or height with joint not suitable for the boiler B. Excessive gas consumption - combustion state is imperfect C. Flames tend to move away D. Flames have yellow tips	A. Replace unsuitable components. B. Adjust gas delivery on the modulating device. C. Check/adjust gas valve pressure stabilizer D. Check that air volutes and Venturi cones of the burner are clean. If items A-B-C-D have been checked with negative result call technical service
5 CONDENSATION IN THE BOILER	A. Flue section or height not suitable (excessive size) B. Boiler operating at low temperature	A. Replace unsuitable components. B. Adjust boiler thermostat at a higher temperature and check if air intake pipe/flue exhaust connection is correct.
6 COLD RADIATORS IN WINTER	A. Summer-winter switch in summer position B. Room thermostat adjusted too low or faulty C. System or radiators closed D. Circulating pump blocked E. 3-way valve faulty	A. Place it in winter position B. Adjust thermostat at a higher temperature or replace it. C. Check if system gate valves and radiator cocks are opened. If item C has been checked with negative result call technical service D. Unblock with a screwdriver and check electrical supply E. Check electricity supply
7 POOR HOT WATER SUPPLY	A. Priority thermostat temperature set too low B. 3-way valve faulty	A. Adjust priority thermostat at a higher temperature or replace it B. Check for correct power supply and correct positioning of valve body

BRUCIATORI
CALDAIE MURALI E TERRA A GAS
GRUPPI TERMICI IN GHISA E IN ACCIAIO
GENERATORI DI ARIA CALDA
TRATTAMENTO ACQUA
CONDIZIONAMENTO

SEI
0444 351044

LAMBORGHINI CALOR S.p.A.
VIA STATALE, 342
44040 DOSSO (FERRARA)
ITALIA
TEL. ITALIA 0532/359811 - EXPORT 0532/359913
FAX ITALIA 0532/359952 - EXPORT 0532/359947